



DECOboard™

Ottimi per ambienti umidi, di facile installazione, economici.

Excellent for humid environments, easy to install and low cost.

60x20

UNYcer-G

Profilo a guscia in resina sintetica di raccordo tra pavimenti e rivestimenti, per vasche e piatti doccia: resistenti ai principali agenti chimici.

La forma a guscia permette di ottenere una migliore pulizia e quindi igiene su tutti gli ambienti interni.

Shell-shaped profile in synthetic resin, designed as a junction between floors and wall coverings, for bathtubs and shower trays. Resistant to most common chemical agents. The shell-shaped design allows for improved cleaning and therefore better hygiene in all indoor environments.

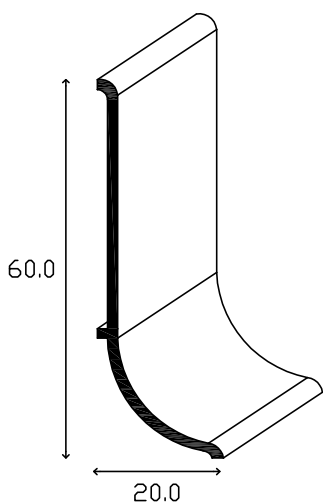

ARTICOLO	MATERIALE	MATERIAL	FINITURA	FINISH	Misura Misura mm	Lung. Leng. mm
SRS6020BI	Resina Sintetica	Synthetic resin	Bianco Ral 9003	White Ral 9003	60x20	2700
SRS6020GR	Resina Sintetica	Synthetic resin	Grigio chiaro	Grey Light	60x20	2700



Bianco Ral 9003
White Ral 9003



Grigio chiaro
Grey Light

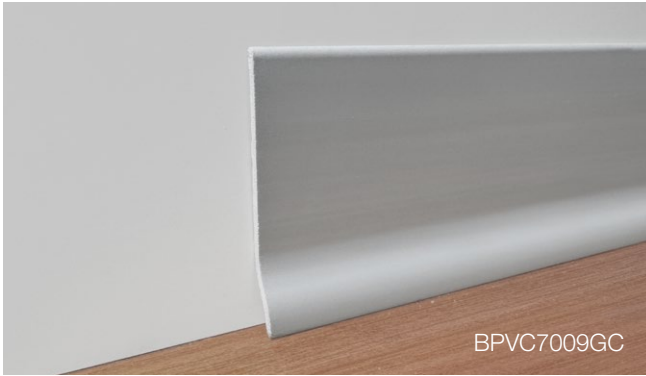

Grigio chiaro
Grey light



Grigio scuro
Grey dark

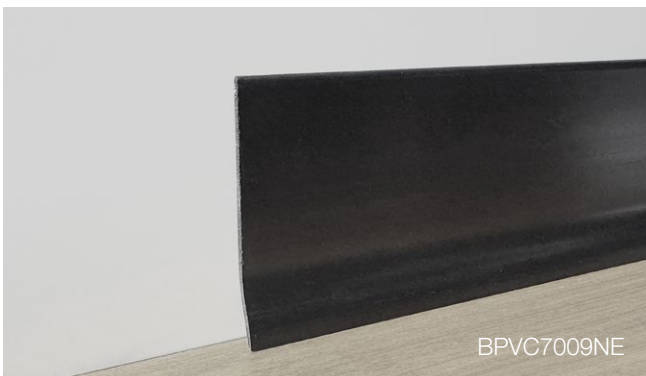

Nero
Black

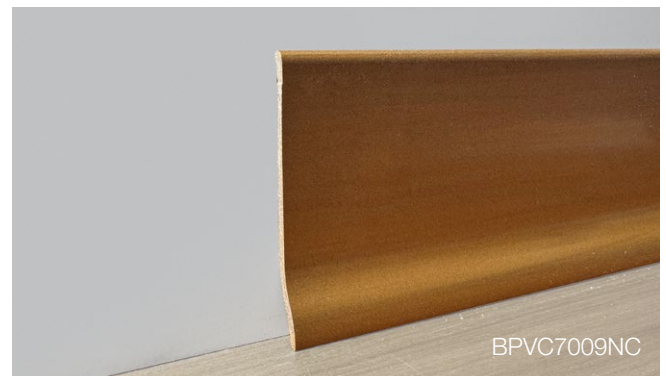

Noce Chiaro
Walnut light



Noce
Walnut



Grigio scuro
Grey dark



Grigio chiaro
Grey light







Bianco
White

82x14

DECOboard™-F

Battiscopa 82X14 PVC con aletta morbida.
Flexible skirting 82x14 PVC with soft seal.

Lunghezza barre 2000mm / Bar length 2000mm

ART.	MATERIALE MATERIAL	COLORE COLOUR	FINITURA / FINISH
BPVCS8214BI	PVC		Bianco / White
BPVCS8214GC	PVC		Grigio chiaro / Grey light
BPVCS8214GS	PVC		Grigio scuro / Grey dark
BPVCS8214NE	PVC		Nero / Black
BPVCS8214NO	PVC		Noce / Walnut

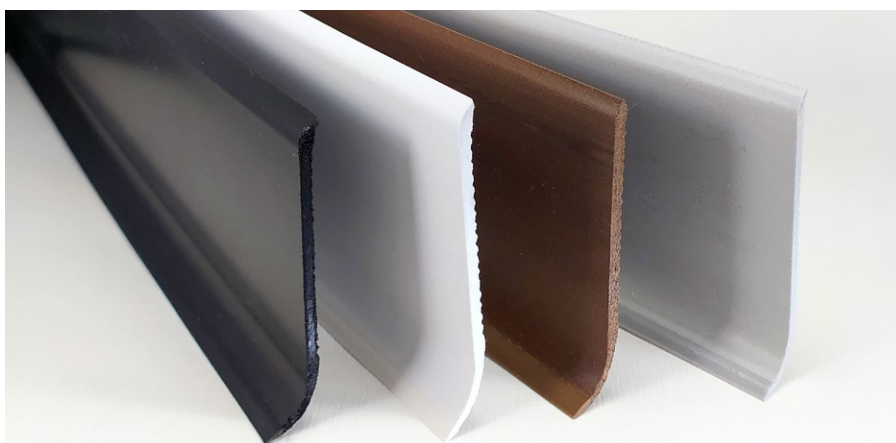
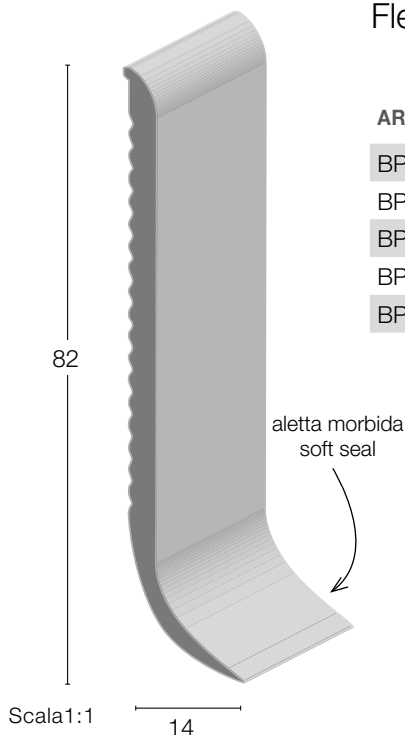





100x16

DECOboard™-F

Battiscopa 100x16 PVC con aletta morbida.
Flexible skirting 100x16 PVC with soft seal.

Lunghezza barre 2000mm / Bar length 2000mm

ART.	MATERIALE MATERIAL	COLORE COLOUR	FINITURA / FINISH
BPVCS10016BI	PVC		Bianco / White
BPVCS10016GC	PVC		Grigio chiaro / Grey light
BPVCS10016GS	PVC		Grigio scuro / Grey dark
BPVCS10016NE	PVC		Nero / Black
BPVCS10016NO	PVC		Noce / Walnut

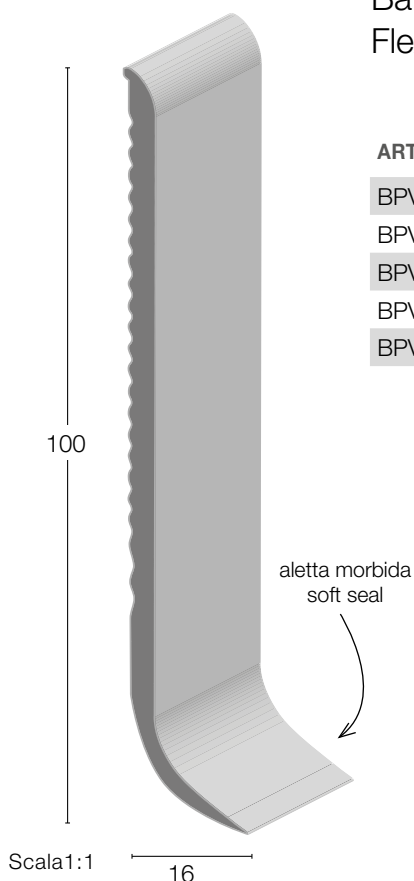

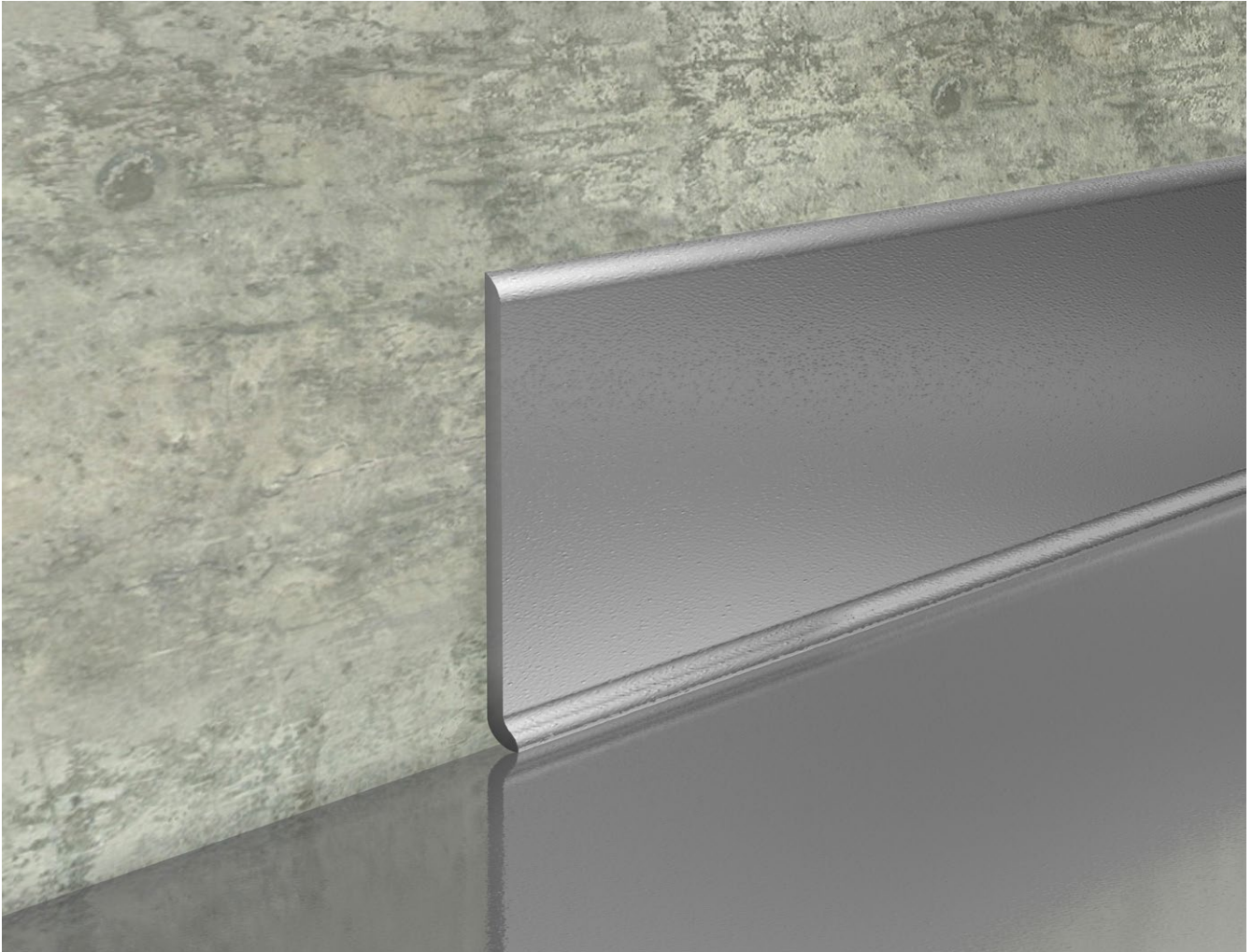

DECOboard™

Battiscopa in PVC rigido o flessibile in varie colorazioni.
Ottimi per ambienti umidi, di facile installazione, economici.

Skirting in rigid or flexible PVC in various colours.
Excellent for humid environments, easy to install and low cost.

Battiscopa 70x9 PVC espanso classe 1 (ignifugo)
Skirting 70x9 class 1 expanded PVC (fire resistant)

70x9

Lunghezza barre 2000mm / Bar length 2000mm

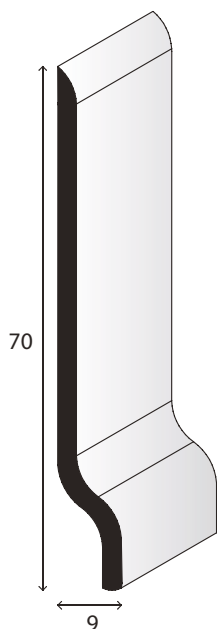

ART.	LEGA ALLOY	COLORE COLOUR	FINITURA FINISH
BPVC7009AZ	PVC espanso Expanded PVC		Azzurro Blue
BPVC7009BI	PVC espanso Expanded PVC		Bianco White
BPVC7009GI	PVC espanso Expanded PVC		Giallo Yellow
BPVC7009GC	PVC espanso Expanded PVC		Grigio chiaro Grey light
BPVC7009GS	PVC espanso Expanded PVC		Grigio scuro Grey dark
BPVC7009NE	PVC espanso Expanded PVC		Nero Black
BPVC7009NO	PVC espanso Expanded PVC		Noce Walnut
BPVC7009NC	PVC espanso Expanded PVC		Noce Chiaro Walnut light
BPVC7009RO	PVC espanso Expanded PVC		Rosso Red
BPVC7009VE	PVC espanso Expanded PVC		Verde Green



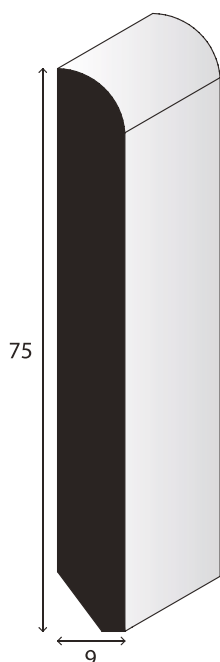

Profili non autoadesivi. / Non self-adhesive profiles.

75x9

Battiscopa 75x9 PVC espanso classe 1 (ignifugo)
Skirting 75x9 class 1 expanded PVC (fire resistant)



Lunghezza barre 2000mm / Bar length 2000mm

ART.	LEGA ALLOY	COLORE COLOUR	FINITURA FINISH
BPVCM7509BI	PVC espanso Expanded PVC		Bianco White
BPVCM7509GC	PVC espanso Expanded PVC		Grigio chiaro Grey light
BPVCM7509GS	PVC espanso Expanded PVC		Grigio scuro Grey dark
BPVCM7509NE	PVC espanso Expanded PVC		Nero Black
BPVCM7509NO	PVC espanso Expanded PVC		Noce Walnut

Profili non autoadesivi. / Non self-adhesive profiles.

Scala 1:1

DECOboard™-F

Battiscopa flessibile 70x5 PVC flessibile classe 1 (ignifugo) - Spessore 1,3 mm.
Flexible skirting 70x5 PVC class 1 (fire resistant) Thickness 1,3 mm.

70x5

ROTOLI 50 ML / ROLLS 50 ML			
ART.	LEGA ALLOY	COLORE COLOUR	FINITURA FINISH
BPVCF700513BI	PVC Flessibile Flexible PVC		Bianco White
BPVCF700513GC	PVC Flessibile Flexible PVC		Grigio chiaro Grey light
BPVCF700513GS	PVC Flessibile Flexible PVC		Grigio scuro Grey dark
BPVCF700513NE	PVC Flessibile Flexible PVC		Nero Black
BPVCF700513NO	PVC Flessibile Flexible PVC		Noce Walnut

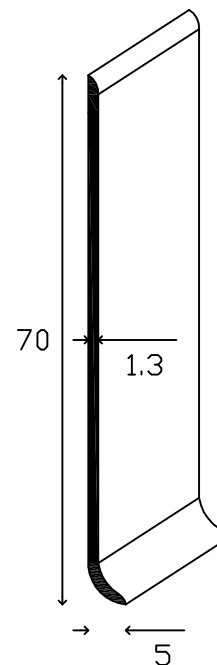
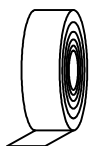

DECOboard™-F

Battiscopa flessibile 70x5 PVC flessibile classe 1 (ignifugo) - Spessore 2,5 mm.
Flexible skirting 70x5 PVC class 1 (fire resistant) Thickness 2,5 mm.

70x5

ROTOLI 50 ML / ROLLS 50 ML			
ART.	LEGA ALLOY	COLORE COLOUR	FINITURA FINISH
BPVCF700525BI	PVC Flessibile Flexible PVC		Bianco White
BPVCF700525GC	PVC Flessibile Flexible PVC		Grigio chiaro Grey light
BPVCF700525GS	PVC Flessibile Flexible PVC		Grigio scuro Grey dark
BPVCF700525NE	PVC Flessibile Flexible PVC		Nero Black
BPVCF700525NO	PVC Flessibile Flexible PVC		Noce Walnut

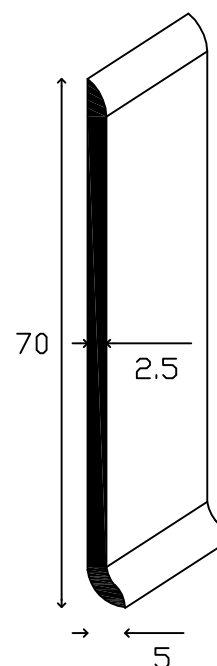
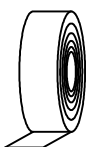

Scala 1:1

70x22

DECOboard™-F

Battiscopa flessibile 70x22 PVC flessibile classe 1 (ignifugo) - Spessore 2 mm.
Flexible skirting 70x22 PVC class 1 (fire resistant) - Thickness 2 mm.

ROTTOLI 50 ML / ROLLS 50 ML

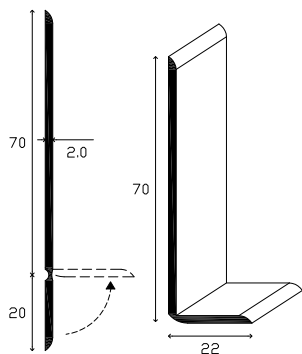

Scala 1:2

ART.	LEGA ALLOY	COLORE COLOUR	FINITURA FINISH
BPVCF702220BI	PVC Flessibile Flexible PVC		Bianco White
BPVCF702220GC	PVC Flessibile Flexible PVC		Grigio chiaro Grey light
BPVCF702220GS	PVC Flessibile Flexible PVC		Grigio scuro Grey dark
BPVCF702220NE	PVC Flessibile Flexible PVC		Nero Black
BPVCF702220NO	PVC Flessibile Flexible PVC		Noce Walnut



Bianco
White

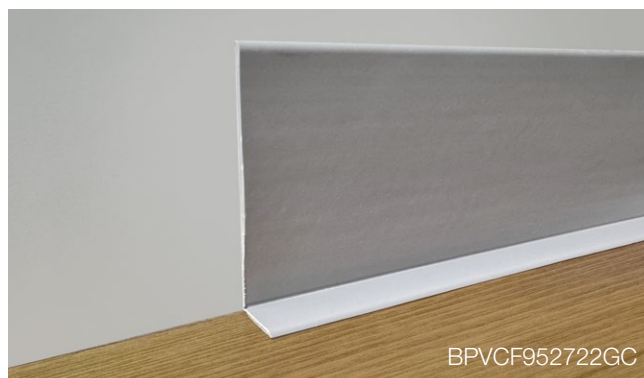

Grigio chiaro
Grey light

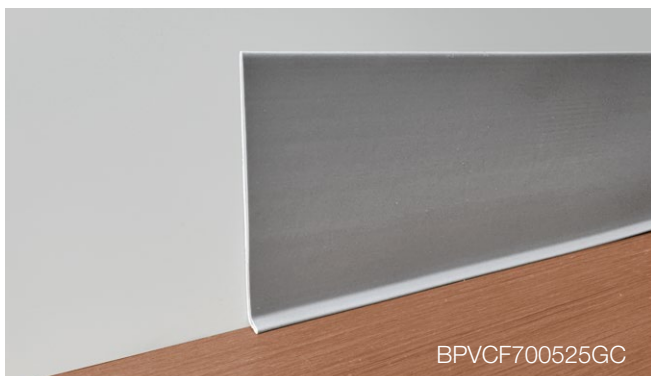

Grigio chiaro
Grey light



Nero
Black

DECOboard™-F

Battiscopa flessibile 95x27 PVC flessibile classe 1 (ignifugo) - Spessore 2,2 mm.
Flexible skirting 95x27 PVC class 1 (fire resistant) Thickness 2,2 mm.

95x27

ROTOLI 50 ML / ROLLS 50 ML

ART.	LEGA ALLOY	COLORE COLOUR	FINITURA FINISH
BPVCF952722BI	PVC Flessibile Flexible PVC		Bianco White
BPVCF952722GC	PVC Flessibile Flexible PVC		Grigio chiaro Grey light
BPVCF952722GS	PVC Flessibile Flexible PVC		Grigio scuro Grey dark
BPVCF952722NE	PVC Flessibile Flexible PVC		Nero Black
BPVCF952722NO	PVC Flessibile Flexible PVC		Noce Walnut

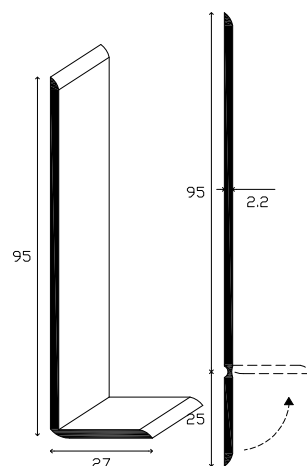

Scala 1:2

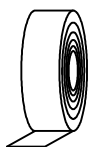

Sistemi di fissaggio per battiscopa in PVC Fixing systems for PVC skirting boards

Adesivo policloroprenico a base solvente a doppia spalmatura specifico per incollaggi rivestimenti resilienti e sgusce su superfici assorbenti o scarsamente assorbenti dove è richiesta una presa immediata.

Solvent-based polychloroprene adhesive with double application, specifically designed for bonding resilient floor coverings and coverings on absorbent or low-absorbent surfaces where immediate grip is required.

ART.	Conf/Kg
COAD406HV/85	0,85
COAD406HV/5	5



Nastro biadesivo in rotolo con proprietà viscoelastiche permanenti.

Double-sided adhesive tape in roll format, featuring permanent viscoelastic properties.

ROTOLI 50 ML / ROLLS 50 ML

ART.	Larghezza Length
JNA40	40
JNA55	55
JNA85	85

