

Decoterm®

**Terminali
per pavimenti
non complanari**

**Trim profiles
for non-coplanar
flooring**



Decoterm®

UNYDECO®

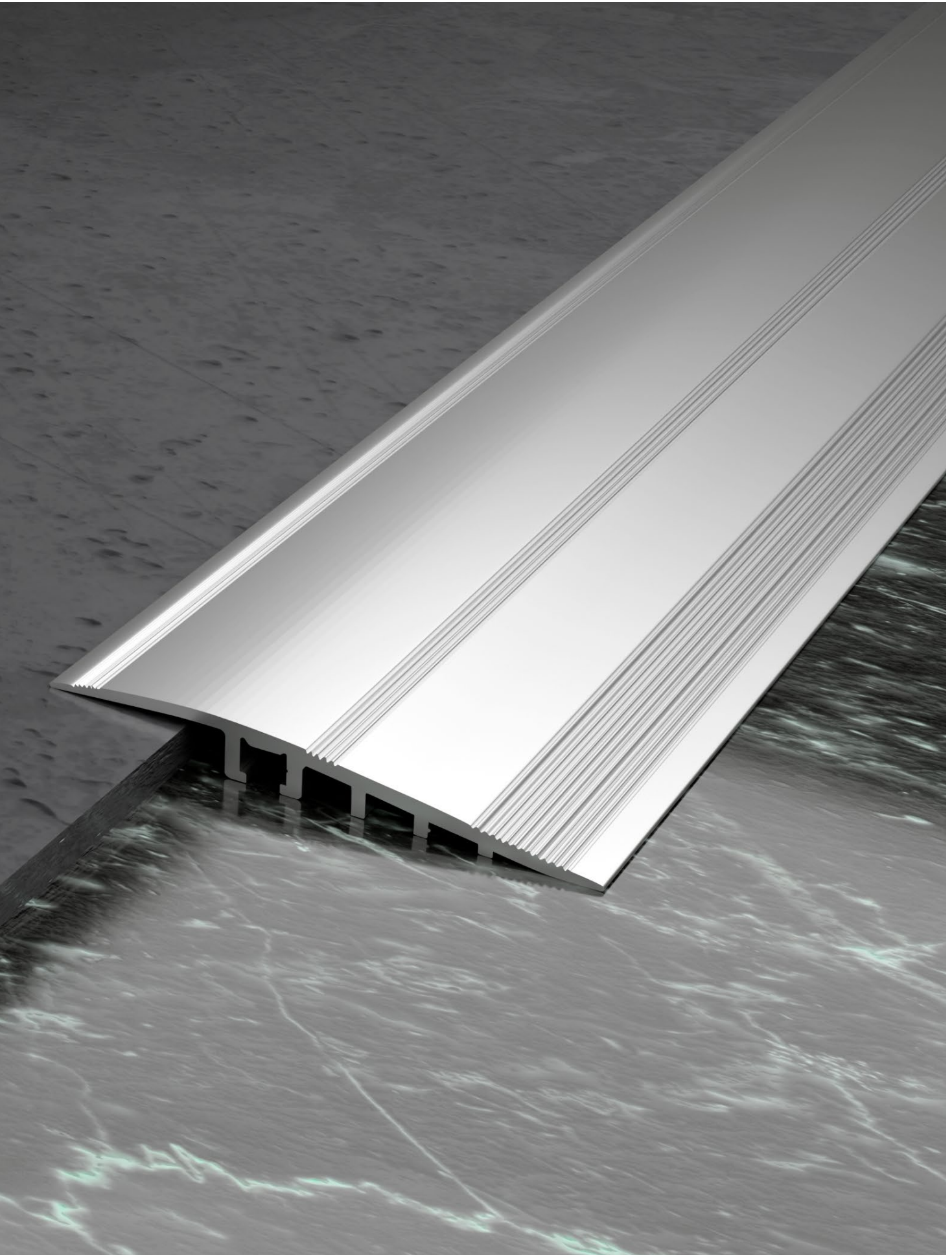

L'autoadesivo hot-melt garantisce un incollaggio rapido e duraturo per una posa veloce e perfetta.

The hot-melt self-adhesive guarantees a quick and long-lasting adhesion for fast and accurate installation.

Terminali di raccordo per pavimenti già posti in opera in parquet, ceramica, marmo, granito e altro, su livelli non complanari.

Jointed trim profiles for flooring that is already laid in parquet, ceramic, marble, granite and others, on non-coplanar levels.

Decoterm®-H

Terminale quarto di tondo 10 x 10 mm.
Quarter round trim profile 10 x 10 mm.

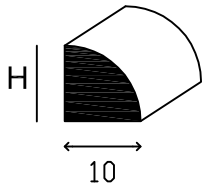

ART.	LEGA ALLOY	FINITURA / FINISH	Lung. mm. Leng. mm	H. mm
QTO1010L	Ottone/ Brass	Lucido con protettivo Polished with protective	2700	10

Terminale H 10

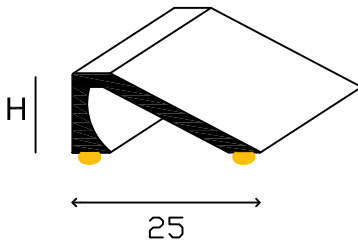

ART.	LEGA ALLOY	FINITURA / FINISH	Lung. mm. Leng. mm	H. mm
THO2510L	Ottone/ Brass	Lucido con protettivo Polished with protective	2700	10
THO2510L-A Adesivo / Adhesive	Ottone/ Brass	Lucido con protettivo Polished with protective	2700	10

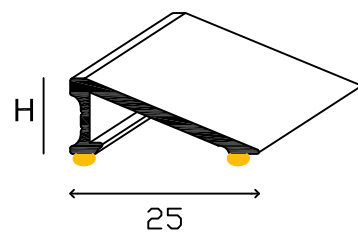

ART.	LEGA ALLOY	FINITURA / FINISH	Lung. mm. Leng. mm	H. mm
THA2510A	Alluminio Aluminum	Argento / Silver	2700	10
THA2510A-A Adesivo / Adhesive	Alluminio Aluminum	Argento / Silver	2700	10

Terminale liscio 25 x 10 mm.

Smooth trim profile 25 x 10 mm.

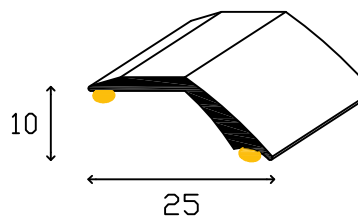

ART.	LEGA ALLOY	FINITURA / FINISH	Lung. mm. Leng. mm	H. mm
TLO2510L	Ottone/ Brass	Lucido con protettivo Polished with protective	2700	10
TLO2510L-A Adesivo / Adhesive	Ottone/ Brass	Lucido con protettivo Polished with protective	2700	10

Terminale liscio 25 x 10 mm.

Smooth trim profile 25 x 10 mm.

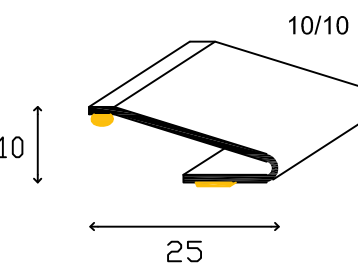

ART.	LEGA ALLOY	FINITURA / FINISH	Lung. mm. Leng. mm	H. mm
TUI2510L/430	Acciaio Inox AISI 304 DIN 1.4301 Stainless steel AISI 304 DIN 1.4301	Lucido con protettivo Polished with protective	2700	10
TUI2510L-A/430 Adesivo/Adhesive	Acciaio Inox AISI 304 DIN 1.4301 Stainless steel AISI 304 DIN 1.4301	Lucido con protettivo Polished with protective	2700	10

Terminali lisci 43 x 15 - 40 x 10 mm.

Smooth trim profile 25 x 10 mm.

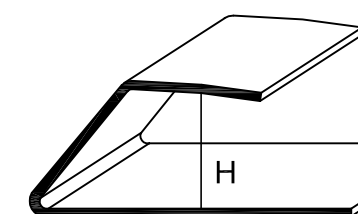

ART.	LEGA ALLOY	FINITURA / FINISH	Lung. mm. Leng. mm	H. mm
TUI4010L/304	Acciaio Inox AISI 304 DIN 1.4301 Stainless steel AISI 304 DIN 1.4301	Lucido con protettivo Polished with protective	2700	10
TUI4010S/304	Acciaio Inox AISI 304 DIN 1.4301 Stainless steel AISI 304 DIN 1.4301	Spazzolato con protettivo Brushed with protective	2700	10
TUI4315L/304	Acciaio Inox AISI 304 DIN 1.4301 Stainless steel AISI 304 DIN 1.4301	Lucido con protettivo Polished with protective	2700	15
TUI4315S/304	Acciaio Inox AISI 304 DIN 1.4301 Stainless steel AISI 304 DIN 1.4301	Spazzolato con protettivo Brushed with protective	2700	15
TUO4010EN	Ottone/ Brass	Naturale / Natural	2700	10
TUO4315EN	Ottone/ Brass	Naturale Natural	2700	15

Esempio di posa
Installation example

Scala 1:2



Scala 1:1

Terminali rigati di raccordo per pavimenti già posti in opera in parquet, ceramica, marmo, granito e altro, su livelli non complanari.

Ridged joint trim profiles for flooring that is already laid in parquet, ceramic, marble, granite and more, on non-coplanar levels.

L'autoadesivo hot-melt garantisce un incollaggio rapido e duraturo per una posa veloce e perfetta.

The hot-melt self-adhesive guarantees a quick and long-lasting adhesion for fast and accurate installation.

Decoterm-R Terminale rigato 35 x 8 mm.
Ridged trim profiles 35 x 8 m.



ART.	LEGA ALLOY	FINITURA / FINISH	Lung. mm. Leng. mm	H. mm
TRA3508A-A Adesivo / Adhesive	Alluminio Aluminum	Argento / Silver	2700	8
TRA3508B-A Adesivo / Adhesive	Alluminio Aluminum	Bronzo / Bronze	2700	8
TRA3508O-A Adesivo / Adhesive	Alluminio Aluminum	Oro / Gold	2700	8
TRO3508L-A Adesivo / Adhesive	Ottone/ Brass	Lucido con protettivo Polished with protective	2700	8

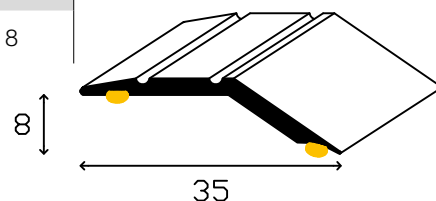

Terminale rigato 43 x 8 mm.
Ridged trim profiles 43 x 8 mm.



ART.	LEGA ALLOY	FINITURA / FINISH	Lung. mm. Leng. mm	H. mm
TRA4308A-F Forato / Drilled	Alluminio Aluminum	Argento / Silver	2700	8
TRA4308B-F Forato / Drilled	Alluminio Aluminum	Bronzo / Bronze	2700	8
TRA4308O-F Forato / Drilled	Alluminio Aluminum	Oro / Gold	2700	8

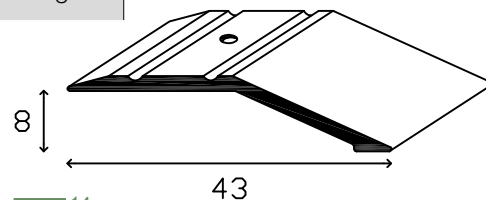

Terminale rigato 45 x 14 mm
Ridged trim profiles 45 x 14 mm.



ART.	LEGA ALLOY	FINITURA / FINISH	Lung. mm. Leng. mm	H. mm
TRA4514A-F Forato / Drilled	Alluminio Aluminum	Argento / Silver	2700	14
TRA4514A-A Adesivo / Adhesive	Alluminio Aluminum	Argento / Silver	2700	14
TRA4514B-F Forato / Drilled	Alluminio Aluminum	Bronzo / Bronze	2700	14
TRA4514B-A Adesivo / Adhesive	Alluminio Aluminum	Bronzo / Bronze	2700	14
TRA4514O-F Forato / Drilled	Alluminio Aluminum	Oro / Gold	2700	14
TRA4514O-A Adesivo / Adhesive	Alluminio Aluminum	Oro / Gold	2700	14
TRO4514L-A Adesivo / Adhesive	Ottone/ Brass	Lucido con protettivo Polished with protective	2700	14

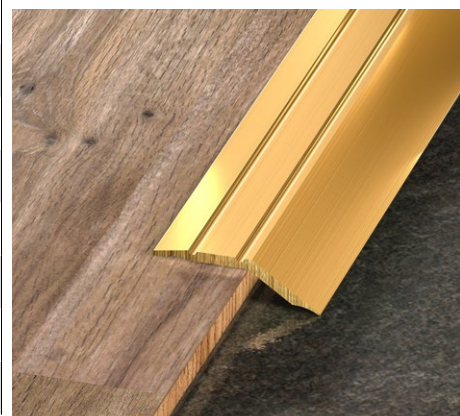

Esempio di posa
Installation example

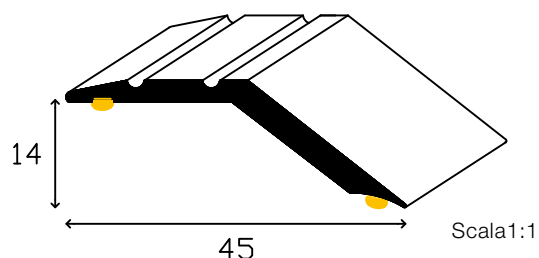
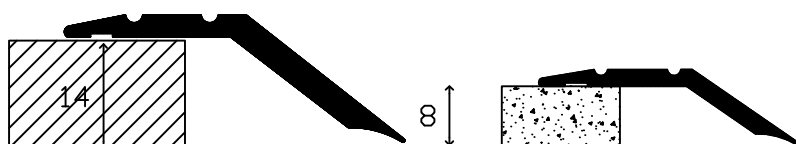

L'autoadesivo hot-melt garantisce un incollaggio rapido e duraturo per una posa veloce e perfetta.

The hot-melt self-adhesive guarantees a quick and long-lasting adhesion for fast and accurate installation.

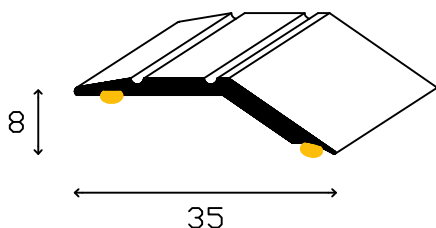

Terminali rigati di raccordo per pavimenti già posti in opera in parquet, ceramica, marmo, granito e altro su livelli non complanari, rivestiti con pellicola effetto legno ad alta resistenza all'abrasione.

Ridged joint trim profiles for flooring that is already laid in parquet, ceramic, marble, granite and more on non-coplanar levels, covered in scratch resistant wood-effect film.

Decoterm-R-R Terminale rigato 35 x 8 mm.
Ridged trim profiles 35 x 8 mm.



ART.	LEGA ALLOY	FINITURA / FINISH	Lung. mm. Leng. mm	H. mm
TRA3508AC-A Adesivo / Adhesive	Alluminio Aluminum	Acero / Maple	2700	8
TRA3508CI-A Adesivo / Adhesive	Alluminio Aluminum	Ciliegio / Cherry	2700	8
TRA3508CC-A Adesivo / Adhesive	Alluminio Aluminum	Ciliegio Chiaro Light Cherry	2700	8
TRA3508FA-A Adesivo / Adhesive	Alluminio Aluminum	Faggio / Beech	2700	8
TRA3508FS-A Adesivo / Adhesive	Alluminio Aluminum	Faggio Scuro Dark Beech	2700	8
TRA3508MM-A Adesivo / Adhesive	Alluminio Aluminum	Merbau/Mogano Merbau/Mahogany	2700	8
TRA3508NO-A Adesivo / Adhesive	Alluminio Aluminum	Noce / Walnut	2700	8
TRA3508NS-A Adesivo / Adhesive	Alluminio Aluminum	Noce Scuro Dark Walnut	2700	8
TRA3508RA-A Adesivo / Adhesive	Alluminio Aluminum	Rovere Antico Antique Oak	2700	8
TRA3508RO-A Adesivo / Adhesive	Alluminio Aluminum	Rovere / Oak	2700	8
TRA3508RSP-A Adesivo / Adhesive	Alluminio Aluminum	Rovere Sbiancato Plus Blanched Plus Oak	2700	8
TRA3508TE-A Adesivo / Adhesive	Alluminio Aluminum	Teak	2700	8
TRA3508WE-A Adesivo / Adhesive	Alluminio Aluminum	Wengè	2700	8

Terminale rigato 45 x 14 mm. / Ridged trim profiles 45 x 14 mm.



ART.	LEGA ALLOY	FINITURA / FINISH	Lung. mm. Leng. mm	H. mm
TRA4514AC-A Adesivo / Adhesive	Alluminio Aluminum	Acero / Maple	2700	14
TRA4514CI-A Adesivo / Adhesive	Alluminio Aluminum	Ciliegio / Cherry	2700	14
TRA4514CC-A Adesivo / Adhesive	Alluminio Aluminum	Ciliegio Chiaro Light Cherry	2700	14
TRA4514FA-A Adesivo / Adhesive	Alluminio Aluminum	Faggio / Beech	2700	14
TRA4514FS-A Adesivo / Adhesive	Alluminio Aluminum	Faggio Scuro Dark Beech	2700	14
TRA4514MM-A Adesivo / Adhesive	Alluminio Aluminum	Merbau/Mogano Merbau/Mahogany	2700	14
TRA4514NO-A Adesivo / Adhesive	Alluminio Aluminum	Noce / Walnut	2700	14
TRA4514NS-A Adesivo / Adhesive	Alluminio Aluminum	Noce Scuro Dark Walnut	2700	14
TRA4514RA-A Adesivo / Adhesive	Alluminio Aluminum	Rovere Antico Antique Oak	2700	14
TRA4514RO-A Adesivo / Adhesive	Alluminio Aluminum	Rovere / Oak	2700	14
TRA4514RSP-A Adesivo / Adhesive	Alluminio Aluminum	Rovere Sbiancato Plus Blanched Plus Oak	2700	14
TRA4514TE-A Adesivo / Adhesive	Alluminio Aluminum	Teak	2700	14
TRA4514WE-A Adesivo / Adhesive	Alluminio Aluminum	Wengè	2700	14

Scala 1:1

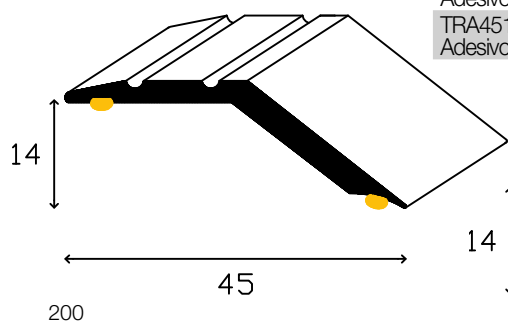

Esempio di posa / Installation example Scala 1:2



Terminali di raccordo per pavimenti già posti in opera in parquet, ceramica, marmo, granito e altro, su livelli non complanari; la particolare forma permette di eliminare in modo funzionale dislivelli da 6 a 16 mm.

Joint trim profiles for flooring that is already laid in parquet, ceramic, marble, granite and more on non-coplanar levels; the special shape permits joining different levels from 6mm to 16mm.

Decoterm-E

Terminali curvi per pavimenti non complanari 20 mm.
Curved trim profiles for non-coplanar flooring 20 mm.

da 7 a 14 mm.



L'autoadesivo hot-melt garantisce un incollaggio rapido e duraturo per una posa veloce e perfetta.

The hot-melt self-adhesive guarantees a quick and long-lasting adhesion for fast and accurate installation.

ART.	LEGA ALLOY	FINITURA / FINISH	Lung. mm. Leng. mm
TEA2108A-A Adesivo / Adhesive	Alluminio Aluminum	Argento / Silver	2700
TEA2108B-A Adesivo / Adhesive	Alluminio Aluminum	Bronzo / Bronze	2700
TEA2108O-A Adesivo / Adhesive	Alluminio Aluminum	Oro / Gold	2700
TEO2108L	Ottone Brass	Lucido con protettivo Polished with protective	2700
TEO2108L-A Adesivo / Adhesive	Ottone Brass	Lucido con protettivo Polished with protective	2700

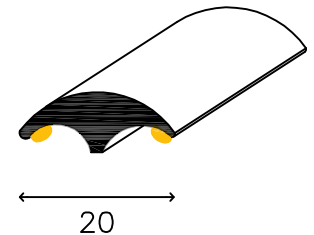

Terminali curvi per pavimenti non complanari 30 mm.
Curved trim profiles for non-coplanar flooring 30 mm.

da 8 a 12 mm.



ART.	LEGA ALLOY	FINITURA / FINISH	Lung. mm. Leng. mm
TEA3010A-A Adesivo / Adhesive	Alluminio Aluminum	Argento / Silver	2700
TEA3010B-A Adesivo / Adhesive	Alluminio Aluminum	Bronzo / Bronze	2700
TEA3010O-A Adesivo / Adhesive	Alluminio Aluminum	Oro / Gold	2700

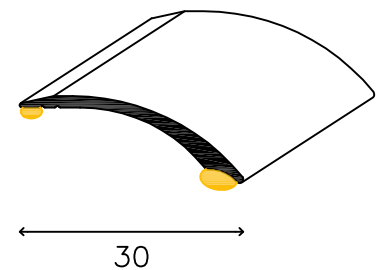

Terminali curvi per pavimenti non complanari 36 mm.
Curved trim profiles for non-coplanar flooring 36 mm.

da 6 a 13 mm.



ART.	LEGA ALLOY	FINITURA / FINISH	Lung. mm. Leng. mm
TEA3613A-A Adesivo / Adhesive	Alluminio Aluminum	Argento / Silver	2700
TEA3613B-A Adesivo / Adhesive	Alluminio Aluminum	Bronzo / Bronze	2700
TEA3613O-A Adesivo / Adhesive	Alluminio Aluminum	Oro / Gold	2700
TEO3613L-A Adesivo / Adhesive	Ottone Brass	Lucido con protettivo Polished with protective	2700

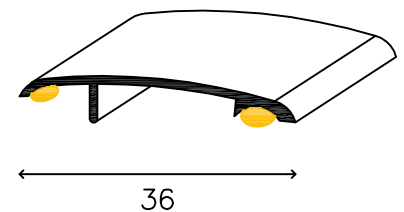

Terminali curvi per pavimenti non complanari 38 mm.
Curved trim profiles for non-coplanar flooring 38 mm.

da 6 a 11 mm.



ART.	LEGA ALLOY	FINITURA / FINISH	Lung. mm. Leng. mm
GDT3869A-A Adesivo / Adhesive	Alluminio Aluminum	Argento / Silver	2700
GDT3869B-A Adesivo / Adhesive	Alluminio Aluminum	Bronzo / Bronze	2700
GDT3869O-A Adesivo / Adhesive	Alluminio Aluminum	Oro / Gold	2700

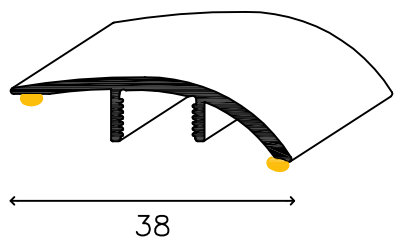

Terminali curvi per pavimenti non complanari 51 mm.
Curved trim profiles for non-coplanar flooring 51 mm.

da 11 a 16 mm.



ART.	LEGA ALLOY	FINITURA / FINISH	Lung. mm. Leng. mm
GDT511216A-A Adesivo / Adhesive	Alluminio Aluminum	Argento / Silver	2700
GDT511216B-A Adesivo / Adhesive	Alluminio Aluminum	Bronzo / Bronze	2700
GDT511216O-A Adesivo / Adhesive	Alluminio Aluminum	Oro / Gold	2700

Scala 1:1

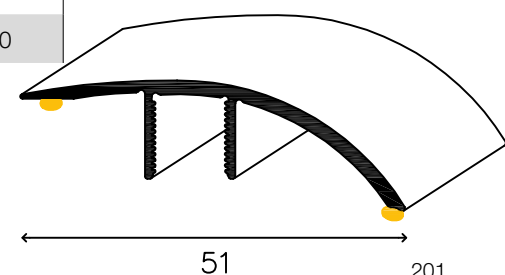

Esempio di posa / Installation example Scala 1:2

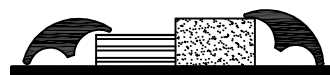
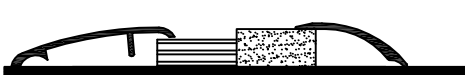

Terminali di raccordo per pavimenti già posti in opera in parquet, ceramica, marmo, granito e altro su livelli non complanari, rivestiti con pellicola effetto legno ad alta resistenza all'abrasione.

Joint trim profiles for flooring that is already laid in parquet, ceramic, marble, granite and others, on non-coplanar levels, covered with scratch resistant wood-effect film

Decoterm®-E-R

Terminali curvi effetto legno per pavimenti non complanari 38 mm.
Curved wood-effect trim profiles for non-coplanar flooring 38 mm.

da 6 a 11 mm.

L'autoadesivo hot-melt garantisce un incollaggio rapido e duraturo per una posa veloce e perfetta.

The hot-melt self-adhesive guarantees a quick and long-lasting adhesion for fast and accurate installation.

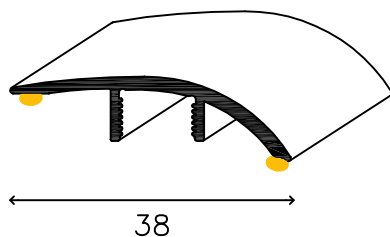

ART.	LEGA ALLOY	FINITURA / FINISH	Lung. mm. Leng. mm
GDT3869AC-A Adesivo / Adhesive	Alluminio Aluminum	Acerò / Maple	2700
GDT3869CI-A Adesivo / Adhesive	Alluminio Aluminum	Ciliegio / Cherry	2700
GDT3869CC-A Adesivo / Adhesive	Alluminio Aluminum	Ciliegio Chiaro Light Cherry	2700
GDT3869FA-A Adesivo / Adhesive	Alluminio Aluminum	Faggio / Beech	2700
GDT3869FS-A Adesivo / Adhesive	Alluminio Aluminum	Faggio Scuro Dark Beech	2700
GDT3869MM-A Adesivo / Adhesive	Alluminio Aluminum	Merbau/Mogano Merbau/Mahogany	2700
GDT3869NO-A Adesivo / Adhesive	Alluminio Aluminum	Noce / Walnut	2700
GDT3869NS-A Adesivo / Adhesive	Alluminio Aluminum	Noce Scuro Dark Walnut	2700
GDT3869RA-A Adesivo / Adhesive	Alluminio Aluminum	Rovere Antico Antique Oak	2700
GDT3869RO-A Adesivo / Adhesive	Alluminio Aluminum	Rovere / Oak	2700
GDT3869RSP-A Adesivo / Adhesive	Alluminio Aluminum	Rovere Sbiancato Plus Blanched Plus Oak	2700
GDT3869TE-A Adesivo / Adhesive	Alluminio Aluminum	Teak	2700
GDT3869WE-A Adesivo / Adhesive	Alluminio Aluminum	Wengè	2700

Terminali curvi effetto legno per pavimenti non complanari 51 mm.
Curved wood-effect trim profiles for non-coplanar flooring 51 mm.

da 11 a 16 mm.

Scala 1:1

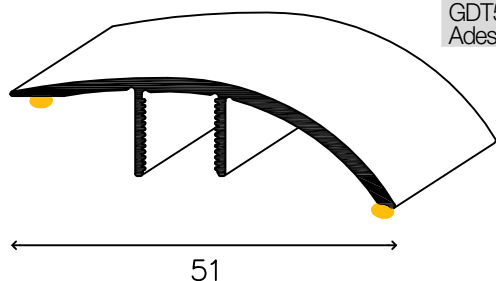

ART.	LEGA ALLOY	FINITURA / FINISH	Lung. mm. Leng. mm
GDT511216AC-A Adesivo / Adhesive	Alluminio Aluminum	Acerò / Maple	2700
GDT511216CI-A Adesivo / Adhesive	Alluminio Aluminum	Ciliegio / Cherry	2700
GDT511216CC-A Adesivo / Adhesive	Alluminio Aluminum	Ciliegio Chiaro Light Cherry	2700
GDT511216FA-A Adesivo / Adhesive	Alluminio Aluminum	Faggio / Beech	2700
GDT511216FS-A Adesivo / Adhesive	Alluminio Aluminum	Faggio Scuro Dark Beech	2700
GDT511216MM-A Adesivo / Adhesive	Alluminio Aluminum	Merbau/Mogano Merbau/Mahogany	2700
GDT511216NO-A Adesivo / Adhesive	Alluminio Aluminum	Noce / Walnut	2700
GDT511216NS-A Adesivo / Adhesive	Alluminio Aluminum	Noce Scuro Dark Walnut	2700
GDT511216RA-A Adesivo / Adhesive	Alluminio Aluminum	Rovere Antico Antique Oak	2700
GDT511216RO-A Adesivo / Adhesive	Alluminio Aluminum	Rovere / Oak	2700
GDT511216RSP-A Adesivo / Adhesive	Alluminio Aluminum	Rovere Sbiancato Plus Blanched Plus Oak	2700
GDT511216TE-A Adesivo / Adhesive	Alluminio Aluminum	Teak	2700
GDT511216WE-A Adesivo / Adhesive	Alluminio Aluminum	Wengè	2700

Esempio di posa / Installation example

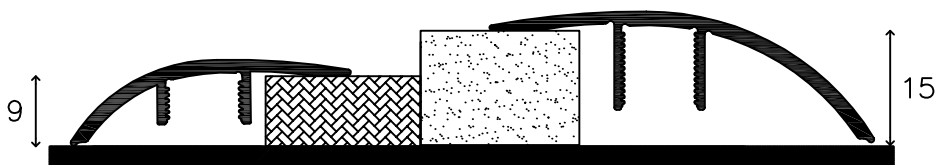

Terminali di raccordo per pavimenti già posti in opera in pvc, linoleum, agugliati, etc.; la particolare forma permette di raccordare dislivelli da 2 a 12 mm. Adatto per tutti i tipi di pavimenti, in particolar modo LVT

Joint trim profiles for flooring already laid in PVC, linoleum, needle punch felts, etc. Its particular shape allows it to join different levels from 2mm to 12 mm. Suitable for all types of floors, especially LVT

L'autoadesivo hot-melt garantisce un incollaggio rapido e duraturo per una posa veloce e perfetta.

The hot-melt self-adhesive guarantees a quick and long-lasting adhesion for fast and accurate installation.

Decoterm-S

Lunghezza barre 2700mm / Bar length 2700mm

Terminale sottile estruso 20 x 2,5 mm. / Extruded slim end cap 20 x 2,5 mm.

ART.	LEGA ALLOY	FINITURA / FINISH	COLORE COLOUR	H. mm
TSA2002A	Alluminio Aluminum	Argento / Silver		2,5
TSA2002A-A Adesivo / Adhesive	Alluminio Aluminum	Argento / Silver		2,5
TSA2002B	Alluminio Aluminum	Bronzo / Bronze		2,5
TSA2002B-A Adesivo / Adhesive	Alluminio Aluminum	Bronzo / Bronze		2,5
TSA2002O	Alluminio Aluminum	Oro / Gold		2,5
TSA2002O-A Adesivo / Adhesive	Alluminio Aluminum	Oro / Gold		2,5
TSO2002L	Ottone Brass	Lucido con protettivo Polished with protective		2,5
TSO2002L-A Adesivo / Adhesive	Ottone Brass	Lucido con protettivo Polished with protective		2,5

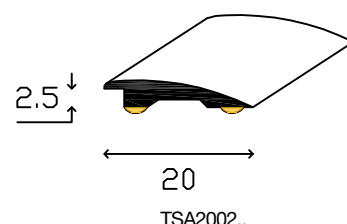

Lunghezza barre 2700mm / Bar length 2700mm

Terminale sottile estruso 29 x 4 mm. / Extruded slim end cap 29 x 4 mm.

ART.	LEGA ALLOY	FINITURA / FINISH	COLORE COLOUR	H. mm
TSA2904A-A Adesivo / Adhesive	Alluminio Aluminum	Argento / Silver		4
TSA2904B-A Adesivo / Adhesive	Alluminio Aluminum	Bronzo / Bronze		4
TSA2904O-A Adesivo / Adhesive	Alluminio Aluminum	Oro / Gold		4
TSO2904L-A Adesivo / Adhesive	Ottone Brass	Lucido con protettivo Polished with protective		4

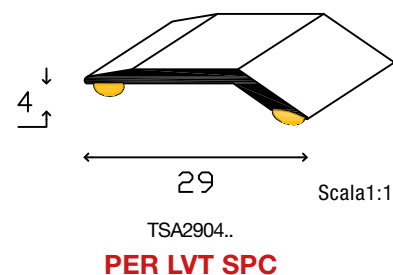

Lunghezza barre 2700mm / Bar length 2700mm

Terminale sottile profilato 38 x 5 mm. / Profiled slim end cap 38 x 5 mm.

ART.	LEGA ALLOY	FINITURA / FINISH	COLORE COLOUR	H. mm
TLI3805L-A/304 Adesivo / Adhesive	Acciaio Inox AISI 304 DIN 1.4301 Stainless steel AISI 304 DIN 1.4301	Lucido con protettivo Polished with protective		5/12
TLI3805S-A/304 Adesivo / Adhesive	Acciaio Inox AISI 304 DIN 1.4301 Stainless steel AISI 304 DIN 1.4301	Spazzolato con protettivo Brushed with protective		5/12
TLO3805L-A Adesivo / Adhesive	Ottone Brass	Lucido con protettivo Polished with protective		5/12

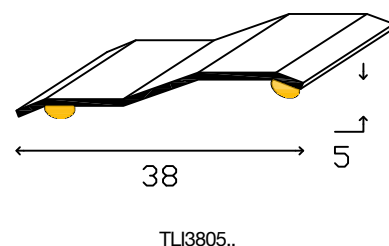

Decoterm-S

Terminale sottile estruso 29 x 5,5 mm.
Extruded slim end cap 29 x 5,5 mm.

5 mm.

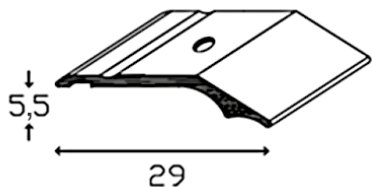

ART.	LEGA ALLOY	FINITURA / FINISH	Lung. mm. Leng. mm	H. mm
TSRA2955930A-F Forato / Drilled	Alluminio Aluminum	Argento / Silver	930	5
TSRA2955A-F Forato / Drilled	Alluminio Aluminum	Argento / Silver	2700	5
TSRA2955930A-A Adesivo / Adhesive	Alluminio Aluminum	Argento / Silver	930	5
TSRA2955A-A Adesivo / Adhesive	Alluminio Aluminum	Argento / Silver	2700	5
TSRA2955930B-F Forato / Drilled	Alluminio Aluminum	Bronzo / Bronze	930	5
TSRA2955B-F Forato / Drilled	Alluminio Aluminum	Bronzo / Bronze	2700	5
TSRA2955930B-A Adesivo / Adhesive	Alluminio Aluminum	Bronzo / Bronze	930	5
TSRA2955B-A Adesivo / Adhesive	Alluminio Aluminum	Bronzo / Bronze	2700	5
TSRA2955930O-F Forato / Drilled	Alluminio Aluminum	Oro / Gold	930	5
TSRA2955O-F Forato / Drilled	Alluminio Aluminum	Oro / Gold	2700	5
TSRA2955930O-A Adesivo / Adhesive	Alluminio Aluminum	Oro / Gold	930	5
TSRA2955O-A Adesivo / Adhesive	Alluminio Aluminum	Oro / Gold	2700	5



Decoterm-S

Terminale sottile estruso 38 x 7 mm.
Extruded slim end cap 38 x 7 mm.

da 7 a 12 mm.

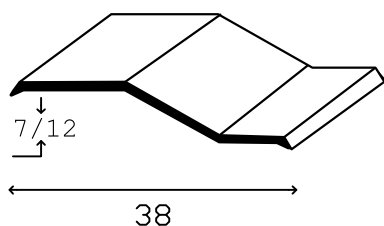

ART.	LEGA ALLOY	FINITURA / FINISH	Lung. mm. Leng. mm	H. mm
TLA3807A-A Adesivo / Adhesive	Alluminio Aluminum	Argento / Silver	2700	7/12
TLA3807B-A Adesivo / Adhesive	Alluminio Aluminum	Bronzo / Bronze	2700	7/12
TLA3807O-A Adesivo / Adhesive	Alluminio Aluminum	Oro / Gold	2700	7/12
TLA3807930A-A Adesivo / Adhesive	Alluminio Aluminum	Argento / Silver	930	7/12
TLA3807930B-A Adesivo / Adhesive	Alluminio Aluminum	Bronzo / Bronze	930	7/12
TLA3807930O-A Adesivo / Adhesive	Alluminio Aluminum	Oro / Gold	930	7/12

Esempio di posa / Installation example Scala1:2



Decoterm-ZL

ART.	LEGA ALLOY	FINITURA / FINISH	Lung. mm. Leng. mm	H. mm
TZA755A	Alluminio Aluminum	Argento / Silver	3000	5

Superficie zigrinata adatto per passaggio carrelli. / Knurled surface suitable for trolleys passage.

Esempio di posa / Installation example

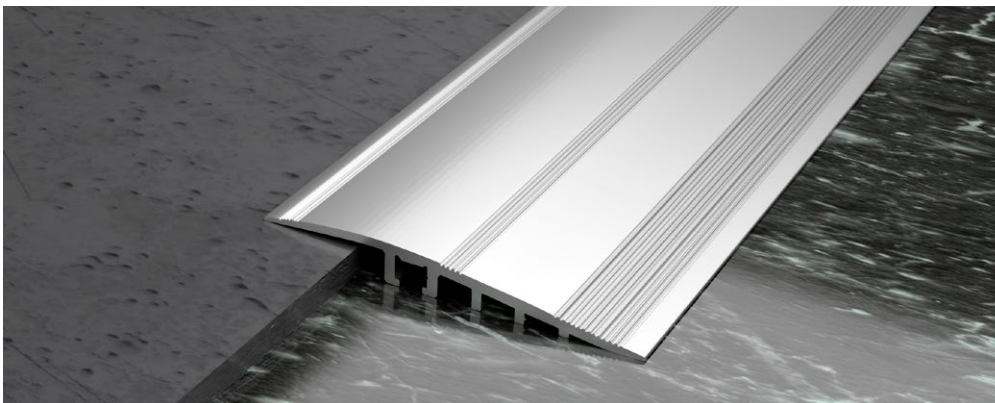
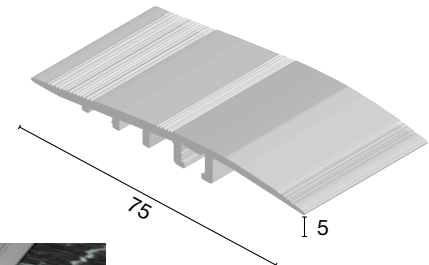

Terminale di raccordo per pavimenti già posti in opera in parquet, ceramica, marmo, granito e altro, su livelli non complanari; per la sua forma reversibile, raccorda spessori di pavimento da 8 mm. a 14 mm.

Joint trim profile for flooring that is already laid in parquet, ceramic, marble, granite and more, on non-coplanar levels; due to its reversible shape, it connects thicknesses of flooring from 8mm to 14mm.

Decoterm®-M

Terminale multiuso per pavimenti non complanari
Multi-use trim profile for non coplanar flooring

da 8 a 14 mm



ART.	LEGA ALLOY	FINITURA / FINISH	Lung. mm. Leng. mm	H. mm
TMO3807L	Ottone/ Brass	Lucido con protettivo Polished with protective	2700	8-14
TMO3807L-A Adesivo / Adhesive	Ottone/Brass	Lucido con protettivo Polished with protective	2700	8-14

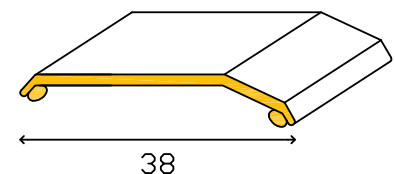

*Articolo disponibile fino ad esaurimento scorte / Article available until stocks last

L'autoadesivo hot-melt garantisce un incollaggio rapido e duraturo per una posa veloce e perfetta.

The hot-melt self-adhesive guarantees a quick and long-lasting adhesion for fast and accurate installation.

Esempio di posa / Installation example

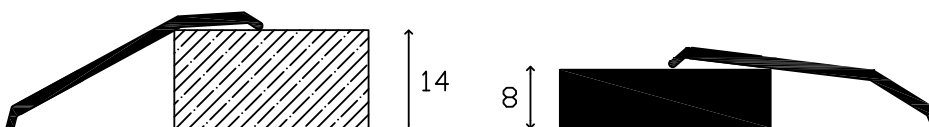

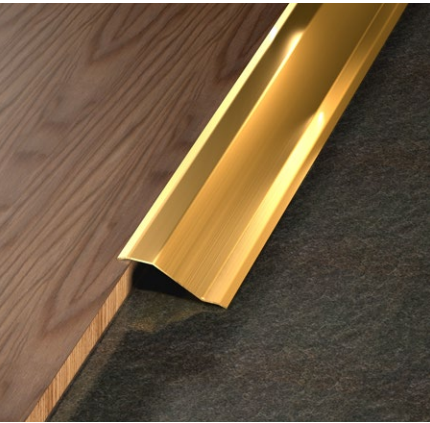

Terminale di raccordo per pavimenti già posti in opera in parquet, ceramica, marmo, granito e altro; per la sua forma riesce a raccordare pavimenti con spessori variabili da 12 a 20 mm

Joint trim profile for flooring that is already laid in parquet, ceramic, marble, granite and more; due to its shape it can connect flooring with thicknesses that vary from 12mm to 20mm.

Terminale 48x20 / End cap 48x20

da 12 a 20 mm

ART.	LEGA ALLOY	FINITURA / FINISH	Lung. mm. Leng. mm	H. mm
TLI4812L-A/304 Adesivo / Adhesive	Acciaio Inox AISI 304 DIN 1.4301 Stainless steel AISI 304 DIN 1.4301	Lucido con protettivo Polished with protective	2700	12-20
TLI4812S-A/304 Adesivo / Adhesive	Acciaio Inox AISI 304 DIN 1.4301 Stainless steel AISI 304 DIN 1.4301	Spazzolato con protettivo Brushed with protective	2700	12-20
TLO4812L-A Adesivo / Adhesive	Ottone/ Brass	Lucido con protettivo Polished with protective	2700	12-20

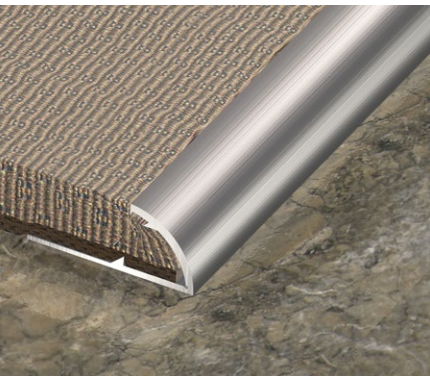

Terminale di raccordo per pavimenti in moquette; la particolare chiusura a schiacciamento ancora il pavimento e ne preserva il bordo.

Joint trim profile for flooring already carpeted; the special snap closures anchor the flooring and protect the edge.

Decoterm®-F Terminale flessibile per pavimenti in moquette
Flexible trim profile for flooring already carpeted

ART.	LEGA ALLOY	FINITURA / FINISH	Lung. mm. Leng. mm
TFA2612A	Alluminio Aluminum	Argento / Silver	2700
TFA2612A-A Adesivo / Adhesive	Alluminio Aluminum	Argento / Silver	2700
TFA2612B	Alluminio Aluminum	Bronzo / Bronze	2700
TFA2612B-A Adesivo / Adhesive	Alluminio Aluminum	Bronzo / Bronze	2700
TFA2612O	Alluminio Aluminum	Oro / Gold	2700
TFA2612O-A Adesivo / Adhesive	Alluminio Aluminum	Oro / Gold	2700

L'autoadesivo hot-melt garantisce un incollaggio rapido e duraturo per una posa veloce e perfetta.

The hot-melt self-adhesive guarantees a quick and long-lasting adhesion for fast and accurate installation.

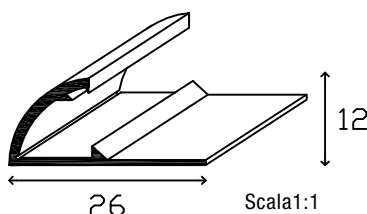

Esempio di posa
Installation example

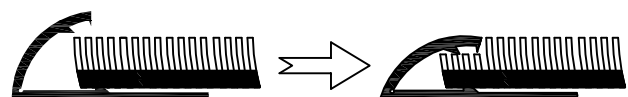

Terminali di raccordo con base ad incastro per pavimentazioni in parquet, ceramica, marmo, granito, pietre naturali e composti in resina.
Joint trim profiles with interlocking base for flooring in parquet, ceramic, marble, granite, natural stone and resin composites.

Le basi dei profili vengono fornite con apposita tranciatura e foratura per una rapida ed efficace posa in opera dei profili.

The bases of the profiles come already prepared drilled and punched for faster and more effective installation of the profiles.

Decoterm®-H-B

Profili terminali curvi su livelli non complanari con base ad incastro
 Curved trim profiles for non-coplanar levels with interlocking bases

ART.	LEGA ALLOY	FINITURA / FINISH	Lung. mm. Leng. mm	H. mm
TQO10033EN	Ottone Brass	Naturale / Natural	2700	10
TQO10033L	Ottone Brass	Lucido con protettivo Polished with protective	2700	10
TQO10033C	Ottone Brass	Cromato con protettivo Chromed with protective	2700	10
TQA15038A	Alluminio Aluminum	Argento / Silver	2700	15

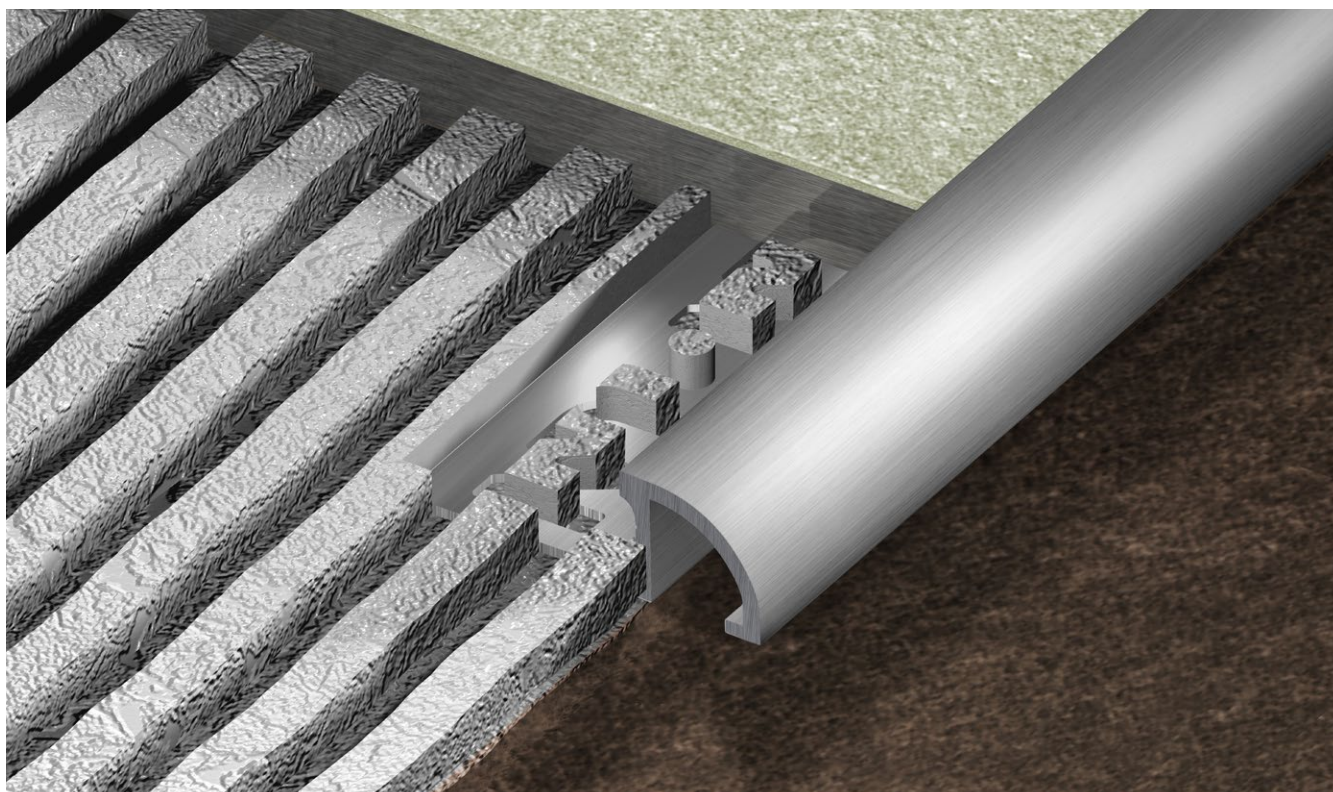
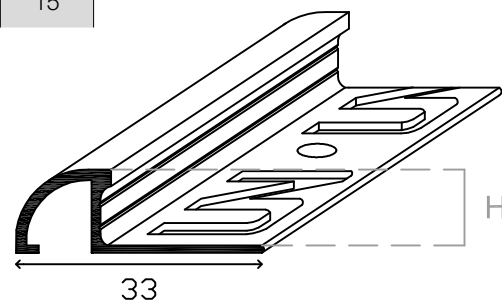

Decoterm®-H-B

Profili terminali obliqui su livelli non complanari con base ad incastro
 Oblique trim profiles for non-coplanar levels with interlocking bases

Lunghezza barre 2700mm / Bar length 2700mm



THA15043A

ART.	LEGA ALLOY	FINITURA / FINISH	COLORE COLOUR	H. mm
THA4530A	Alluminio Aluminum	Argento / Silver		4,5

Lunghezza barre 2700mm / Bar length 2700mm

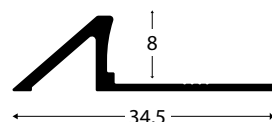

THA8037A

ART.	LEGA ALLOY	FINITURA / FINISH	COLORE COLOUR	H. mm
THA8037A	Alluminio Aluminum	Argento / Silver		8

NEW!

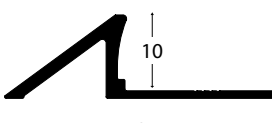

THA10037..
THO10037..

THA10037A	Alluminio Aluminum	Argento / Silver		10
-----------	-----------------------	------------------	--	----

THA15043A	Alluminio Aluminum	Argento / Silver		15
-----------	-----------------------	------------------	--	----

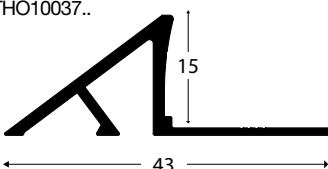

THO10037EN

THO10037EN	Ottone Brass	Naturale / Natural		10
------------	-----------------	--------------------	--	----

THO10037L	Ottone Brass	Lucido con protettivo Polished with protective		10
-----------	-----------------	---	--	----

THO10037C	Ottone Brass	Cromato con protettivo Chromed with protective		10
-----------	-----------------	---	--	----

THO15043EN

THO15043EN	Ottone Brass	Naturale / Natural		15
------------	-----------------	--------------------	--	----

THO15043L	Ottone Brass	Lucido con protettivo Polished with protective		15
-----------	-----------------	---	--	----

THO15043C	Ottone Brass	Cromato con protettivo Chromed with protective		15
-----------	-----------------	---	--	----

Lunghezza barre 3000mm / Bar length 3000mm

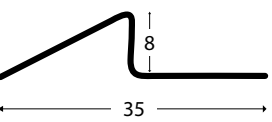

THI8035...

ART.	LEGA ALLOY	FINITURA / FINISH	COLORE COLOUR	H. mm
THI8035L/304	Acciaio Inox AISI 304 DIN 1.4301 Stainless steel AISI 304 DIN 1.4301	Lucido con protettivo Polished with protective		8

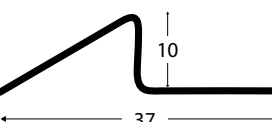

THI8035S...

THI8035S/304	Acciaio Inox AISI 304 DIN 1.4301 Stainless steel AISI 304 DIN 1.4301	Spazzolato con protettivo Brushed with protective		8
--------------	---	--	--	---

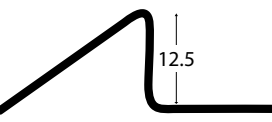

THI10037...

THI10037L/304	Acciaio Inox AISI 304 DIN 1.4301 Stainless steel AISI 304 DIN 1.4301	Lucido con protettivo Polished with protective		10
---------------	---	---	--	----

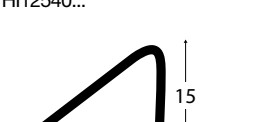

THI10037S...

THI10037S/304	Acciaio Inox AISI 304 DIN 1.4301 Stainless steel AISI 304 DIN 1.4301	Spazzolato con protettivo Brushed with protective		10
---------------	---	--	--	----

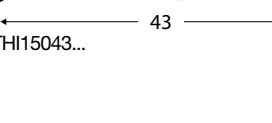

THI12540...

THI12540L/304	Acciaio Inox AISI 304 DIN 1.4301 Stainless steel AISI 304 DIN 1.4301	Lucido con protettivo Polished with protective		12,5
---------------	---	---	--	------



THI12540S...

THI12540S/304	Acciaio Inox AISI 304 DIN 1.4301 Stainless steel AISI 304 DIN 1.4301	Spazzolato con protettivo Brushed with protective		12,5
---------------	---	--	--	------



THI15043L...

THI15043L/304	Acciaio Inox AISI 304 DIN 1.4301 Stainless steel AISI 304 DIN 1.4301	Lucido con protettivo Polished with protective		15
---------------	---	---	--	----

THI15043S/304	Acciaio Inox AISI 304 DIN 1.4301 Stainless steel AISI 304 DIN 1.4301	Spazzolato con protettivo Brushed with protective		15
---------------	---	--	--	----

Esempio di posa
Installation example

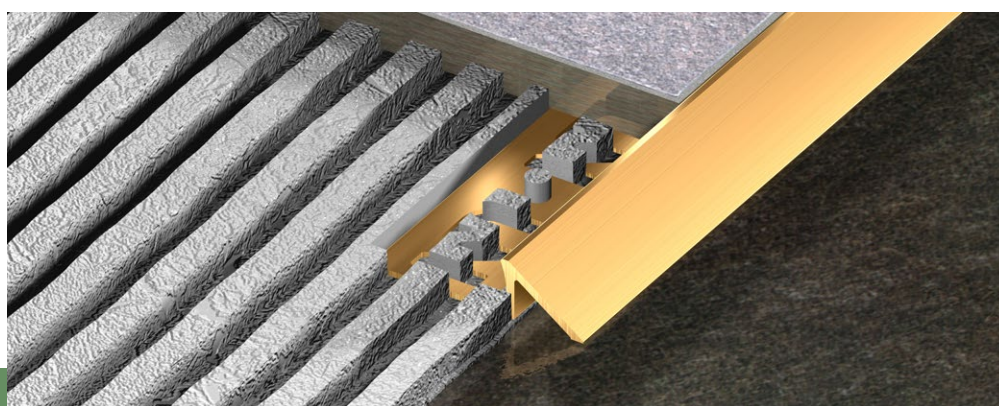
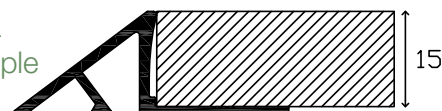

Terminali di raccordo con base ad incastro per pavimentazioni in parquet, ceramica, marmo, granito, pietre naturali e composti in resina.

Joint trim profiles with interlocking base for flooring in parquet, ceramic, marble, granite, natural stone and resin composites.

Le basi dei profili vengono fornite con apposita tranciatura e foratura per una rapida ed efficace posa in opera dei profili.

The bases of the profiles come already prepared drilled and punched for faster and more effective installation of the profiles.

Decoterm®-H-B

Profili terminali obliqui su livelli non complanari con base ad incastro e aletta di copertura

Oblique trim profiles for non-coplanar levels with interlocking bases and covering tab

ART.	LEGA ALLOY	FINITURA FINISH	Lung. mm. Leng. mm	H. mm
THA8048A	Alluminio / Aluminum	Argento / Silver	2700	8

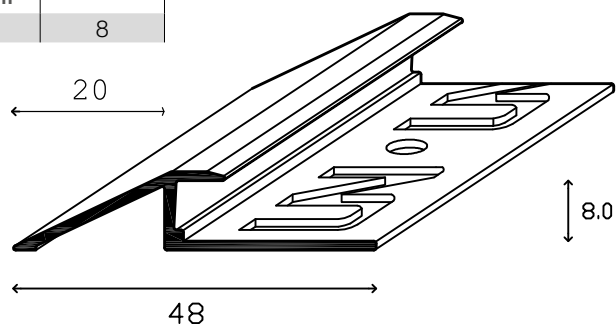

ART.	LEGA ALLOY	FINITURA FINISH	Lung. mm. Leng. mm	H. mm
THA10052A	Alluminio / Aluminum	Argento / Silver	2700	10

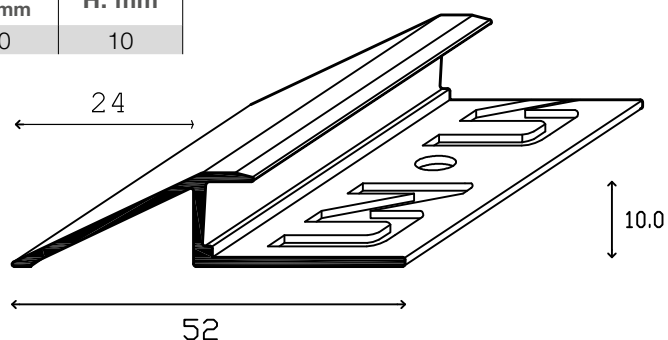

ART.	LEGA ALLOY	FINITURA FINISH	Lung. mm. Leng. mm	H. mm
THA15062A	Alluminio / Aluminum	Argento / Silver	2700	15

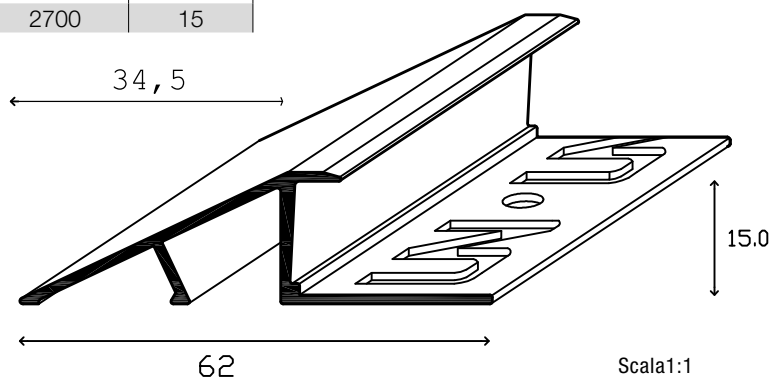

Esempio di posa
Installation example

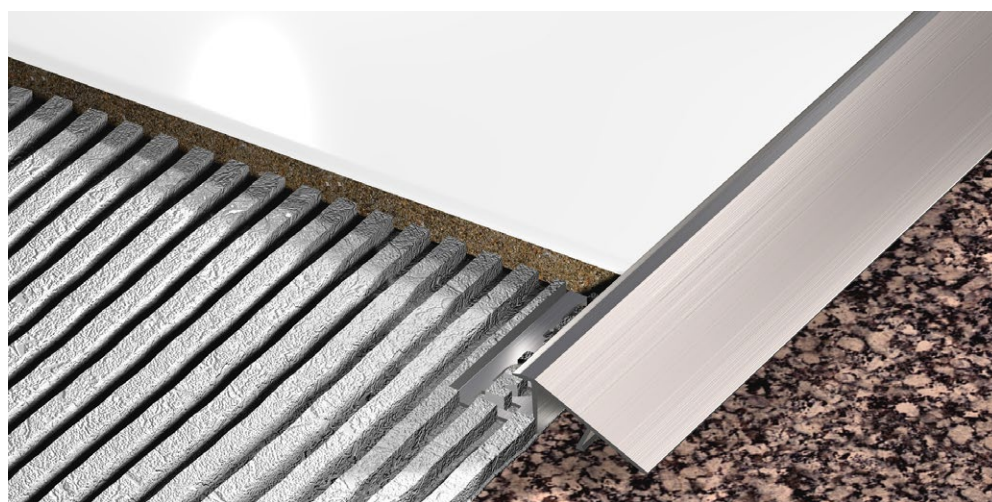
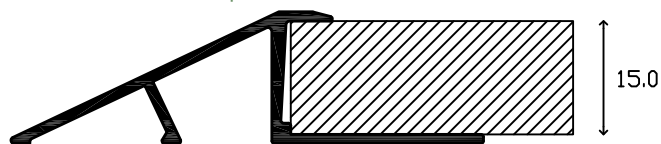

Le basi dei profili vengono fornite con apposita tranciatura e foratura per una rapida ed efficace posa in opera dei profili.

The bases of the profiles come already prepared drilled and punched for faster and more effective installation of the profiles.

Terminali di raccordo con base ad incastro per pavimentazioni in parquet, ceramica, marmo, granito, pietre naturali e composti in resina. L'inclinazione di questi profili favorisce il passaggio di carrelli o sedie a rotelle.

Joint trim profiles with interlocking base for flooring in parquet, ceramic, marble, granite, natural stone and resin composites. The inclination of these profiles favors the passage of trolleys or wheelchairs.

Decoterm-H-B

Profili terminali obliqui su livelli non complanari con base ad incastro e aletta di copertura

Oblique trim profiles for non-coplanar levels with interlocking bases and covering tab

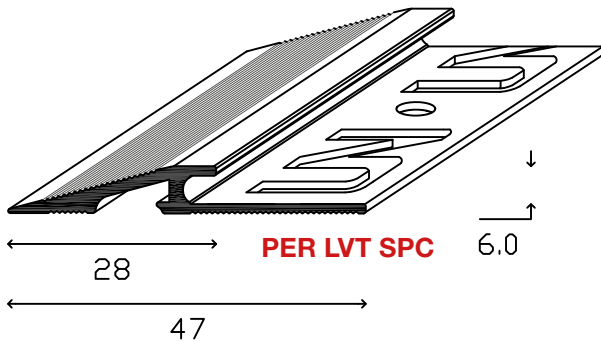

ART.	LEGA ALLOY	FINITURA FINISH	Lung. mm. Leng. mm	H. mm
THA6047A	Alluminio Aluminum	Argento Silver	2700	6

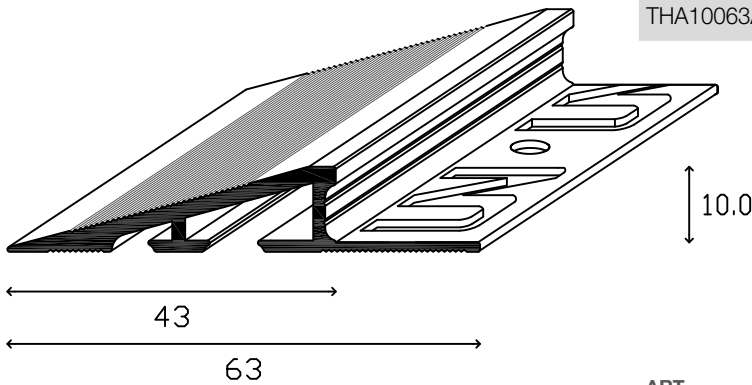

ART.	LEGA ALLOY	FINITURA FINISH	Lung. mm. Leng. mm	H. mm
THA10063A	Alluminio Aluminum	Argento Silver	2700	10

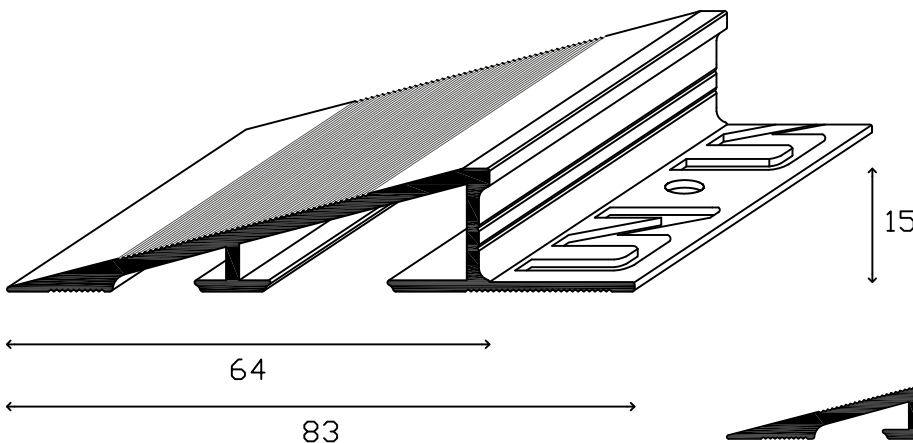

ART.	LEGA ALLOY	FINITURA FINISH	Lung. mm. Leng. mm	H. mm
THA15083A	Alluminio Aluminum	Argento Silver	2700	15

Esempio di posa
Installation example

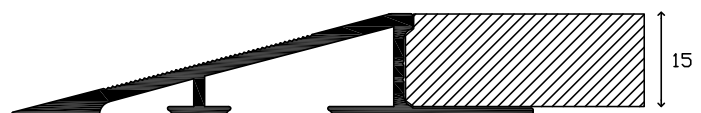

Soglie di raccordo in legno massello con base ad incastro per pavimentazioni in parquet, ceramica, marmo, granito, pietre naturali e composti in resina.
Joint threshold cover in solid wood with interlocking base for flooring in parquet, ceramic, marble, granite, natural stone and resin composites.

Soglie terminali in legno massello su livelli non complanari con base ad incastro

Ending soles in pure wood on non-coplanar levels with interlocking bases

Decoterm®-HL-B

Soglie terminali in legno massello su livelli non complanari con base ad incastro*
 Ending soles in pure wood on non-coplanar levels with interlocking bases*

ART.	ESSENZA WOOD	FINITURA FINISH	Lung. mm. Leng. mm	H. mm
THL1004DOV	Doussiè	Verniciato / Painted	900 / 1800 / 2700	10
THL1004DOGR	Doussiè	Grezzo / Untreated	900 / 1800 / 2700	10
THL10040IRV	Iroko	Verniciato / Painted	900 / 1800 / 2700	10
THL10040IRGR	Iroko	Grezzo / Untreated	900 / 1800 / 2700	10
THL10040LAV	Larice / Larch	Verniciato / Painted	900 / 1800 / 2700	10
THL10040LAGR	Larice / Larch	Grezzo / Untreated	900 / 1800 / 2700	10
THL10040ROV	Rovere / Oak	Verniciato / Painted	900 / 1800 / 2700	10
THL10040ROS	Rovere / Oak	Sbiancato / Bleached	900 / 1800 / 2700	10
THL10040ROSI	Rovere / Oak	Sbiancato Ice Bleached Ice	900 / 1800 / 2700	10
THL10040ROWI	Rovere / Oak	Sbiancato White Ice Bleached White Ice	900 / 1800 / 2700	10
THL10040ROGR	Rovere / Oak	Grezzo / Untreated	900 / 1800 / 2700	10
THL10040TEV	Teak	Verniciato / Painted	900 / 1800 / 2700	10
THL10040TEGR	Teak	Grezzo / Untreated	900 / 1800 / 2700	10

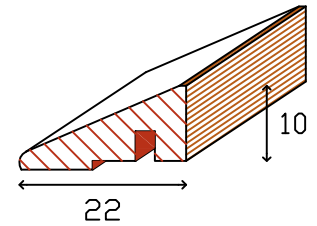

ART.	ESSENZA WOOD	FINITURA FINISH	Lung. mm. Leng. mm	H. mm
THL1505DOV	Doussiè	Verniciato / Painted	900 / 1800 / 2700	15
THL1505DOGR	Doussiè	Grezzo / Untreated	900 / 1800 / 2700	15
THL15050IRV	Iroko	Verniciato / Painted	900 / 1800 / 2700	15
THL15050IRGR	Iroko	Grezzo / Untreated	900 / 1800 / 2700	15
THL15050LAV	Larice / Larch	Verniciato / Painted	900 / 1800 / 2700	15
THL15050LAGR	Larice / Larch	Grezzo / Untreated	900 / 1800 / 2700	15
THL15050ROV	Rovere / Oak	Verniciato / Painted	900 / 1800 / 2700	15
THL15050ROS	Rovere / Oak	Sbiancato / Bleached	900 / 1800 / 2700	15
THL15050ROSI	Rovere / Oak	Sbiancato Ice Bleached Ice	900 / 1800 / 2700	15
THL15050ROWI	Rovere / Oak	Sbiancato White Ice Bleached White Ice	900 / 1800 / 2700	15
THL15050ROGR	Rovere / Oak	Grezzo / Untreated	900 / 1800 / 2700	15
THL15050TEV	Teak	Verniciato / Painted	900 / 1800 / 2700	15
THL15050TEGR	Teak	Grezzo / Untreated	900 / 1800 / 2700	15

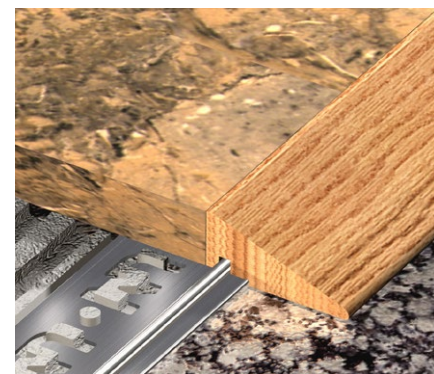
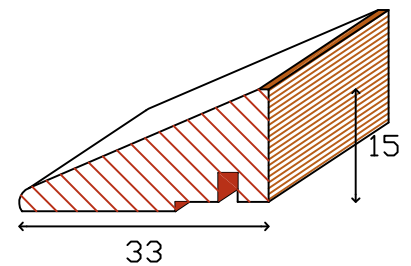

*Alcune essenze legnose sono disponibili fino ad esaurimento scorte.
 Some wood essences are available while stocks last.

Basi ad incastro tranciate per la posa delle soglie
Interlocking bases punched for installing threshold covers

ART.	LEGA ALLOY	FINITURA FINISH	Lung. mm. Leng. mm
BTHL1015EN	Alluminio / Aluminum	Argento / Silver	2700

Esempio di posa
 Installation example

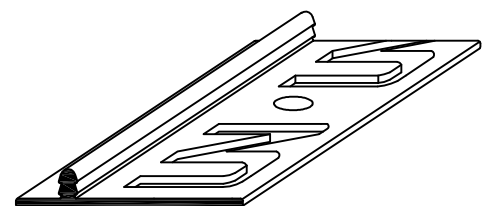
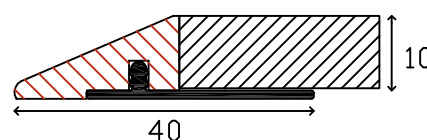
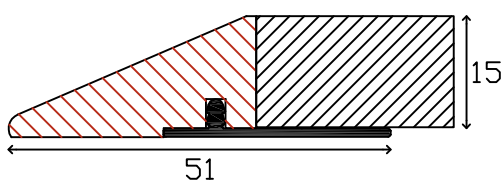

Decoterm®

Profili
di limitazione
perimetrale
Perimeter
limit profiles



Decoterm®

UNYDECO®



Terminale perimetrale di raccordo tra rivestimento verticale e pavimento; può essere usato anche come giunto di dilatazione perimetrale.

Perimeter limit profiles that cover the join between vertical cladding and flooring; it can also be used as a perimeter expansion joint.

Decoterm-T Terminale perimetrale di contenimento e rifinitura
Perimeter limit profile for containment and finishing

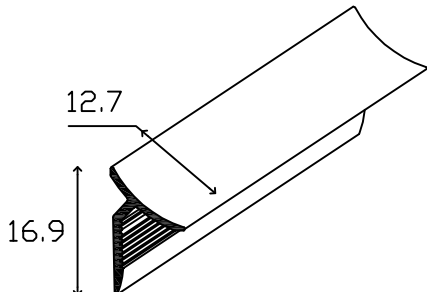

ART.	LEGA / ALLOY	FINITURA / FINISH	Lung. mm. Leng. mm	H. mm
AEA169A	Alluminio / Aluminium	Argento / Silver	2700	8

Esempio di posa
Installation example

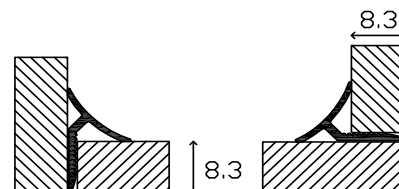

Terminali perimetrali per pavimenti in parquet e flottanti; possono essere usati anche come giunti di dilatazione perimetrale o come profili di chiusura in presenza di porte scorrevoli o bussole per zerbini.

Perimeter limit profiles for parquet and floating flooring; they can also be used as perimeter expansion joints or as closure profiles for sliding doors or trim profiles for doormat recesses.

Decoterm-U Terminali perimetrali e di contenimento
Perimeter and containment limit profiles

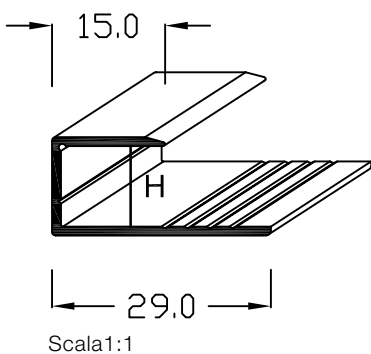

ART.	LEGA ALLOY	FINITURA / FINISH	Curvabile Bendable	Lung. mm. Leng. mm	H. mm
TUA2905A	Alluminio / Aluminium	Argento / Silver		2700	5
TUA2905B	Alluminio / Aluminium	Bronzo / Bronze		2700	5
TUA2905O	Alluminio / Aluminium	Oro / Gold		2700	5
TUA2906A	Alluminio / Aluminium	Argento / Silver		2700	6
TUA2906B	Alluminio / Aluminium	Bronzo / Bronze		2700	6
TUA2906O	Alluminio / Aluminium	Oro / Gold		2700	6
TUA2907A	Alluminio / Aluminium	Argento / Silver		2700	7
TUA2907A-C	Alluminio / Aluminium	Argento / Silver	☒	2700	7
TUA2907B	Alluminio / Aluminium	Bronzo / Bronze		2700	7
TUA2907B-C	Alluminio / Aluminium	Bronzo / Bronze	☒	2700	7
TUA2907O	Alluminio / Aluminium	Oro / Gold		2700	7
TUA2907O-C	Alluminio / Aluminium	Oro / Gold	☒	2700	7
TUA2909A	Alluminio / Aluminium	Argento / Silver		2700	9
TUA2909A-C	Alluminio / Aluminium	Argento / Silver	☒	2700	9
TUA2909B	Alluminio / Aluminium	Bronzo / Bronze		2700	9
TUA2909B-C	Alluminio / Aluminium	Bronzo / Bronze	☒	2700	9
TUA2909O	Alluminio / Aluminium	Oro / Gold		2700	9
TUA2909O-C	Alluminio / Aluminium	Oro / Gold	☒	2700	9
TUA2911A	Alluminio / Aluminium	Argento / Silver		2700	11
TUA2911A-C	Alluminio / Aluminium	Argento / Silver	☒	2700	11
TUA2911B	Alluminio / Aluminium	Bronzo / Bronze		2700	11
TUA2911B-C	Alluminio / Aluminium	Bronzo / Bronze	☒	2700	11
TUA2911O	Alluminio / Aluminium	Oro / Gold		2700	11
TUA2911O-C	Alluminio / Aluminium	Oro / Gold	☒	2700	11
TUA2913A	Alluminio / Aluminium	Argento / Silver		2700	13
TUA2913A-C	Alluminio / Aluminium	Argento / Silver	☒	2700	13
TUA2913B	Alluminio / Aluminium	Bronzo / Bronze		2700	13
TUA2913B-C	Alluminio / Aluminium	Bronzo / Bronze	☒	2700	13
TUA2913O	Alluminio / Aluminium	Oro / Gold		2700	13
TUA2913O-C	Alluminio / Aluminium	Oro / Gold	☒	2700	13
TUA2915A	Alluminio / Aluminium	Argento / Silver		2700	15
TUA2915A-C	Alluminio / Aluminium	Argento / Silver	☒	2700	15
TUA2915B	Alluminio / Aluminium	Bronzo / Bronze		2700	15
TUA2915B-C	Alluminio / Aluminium	Bronzo / Bronze	☒	2700	15
TUA2915O	Alluminio / Aluminium	Oro / Gold		2700	15
TUA2915O-C	Alluminio / Aluminium	Oro / Gold	☒	2700	15

NEW!
NEW!
NEW!
NEW!
NEW!

Esempio di posa
Installation example

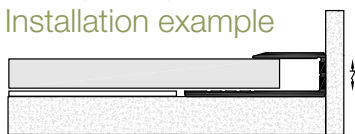

☒ Profili curvabili e/o sagomabili manualmente o con macchina Unymac (vedi pag. 335)
Curved profiles and/or manually shaped or by the Unymac calender machine (see p. 335)

Terminali perimetrali e di contenimento rivestiti con pellicola effetto legno ad alta resistenza all'abrasione. Perimeter and containment limit profiles covered with a highly scratch resistant wood-effect film.



Decoterm®-U-R

Terminali perimetrali e di contenimento rivestiti effetto legno
Perimeter and containment trim profiles covered with wood-effect film

ART.	LEGA ALLOY	FINITURA / FINISH	Lung. mm. Leng. mm	H. mm
TUA2907AC	Alluminio / Aluminium	Acero / Maple	2700	7
TUA2907CI	Alluminio / Aluminium	Ciliegio / Cherry	2700	7
TUA2907CC	Alluminio / Aluminium	Ciliegio Chiaro Light Cherry	2700	7
TUA2907FA	Alluminio / Aluminium	Faggio / Beech	2700	7
TUA2907FS	Alluminio / Aluminium	Faggio Scuro / Dark Beech	2700	7
TUA2907MM	Alluminio / Aluminium	Merbau/Mogano Merbau/Mahogany	2700	7
TUA2907NO	Alluminio / Aluminium	Noce / Walnut	2700	7
TUA2907NS	Alluminio / Aluminium	Noce Scuro / Dark Walnut	2700	7
TUA2907RA	Alluminio / Aluminium	Rovere Antico / Antique Oak	2700	7
TUA2907RO	Alluminio / Aluminium	Rovere / Oak	2700	7
TUA2907RSP	Alluminio / Aluminium	Rovere Sbiancato Plus Blanched Plus Oak	2700	7
TUA2907TE	Alluminio / Aluminium	Teak	2700	7
TUA2907WE	Alluminio / Aluminium	Wengè	2700	7
TUA2909AC	Alluminio / Aluminium	Acero / Maple	2700	9
TUA2909CI	Alluminio / Aluminium	Ciliegio / Cherry	2700	9
TUA2909CC	Alluminio / Aluminium	Ciliegio Chiaro Light Cherry	2700	9
TUA2909FA	Alluminio / Aluminium	Faggio / Beech	2700	9
TUA2909FS	Alluminio / Aluminium	Faggio Scuro / Dark Beech	2700	9
TUA2909MM	Alluminio / Aluminium	Merbau/Mogano Merbau/Mahogany	2700	9
TUA2909NO	Alluminio / Aluminium	Noce / Walnut	2700	9
TUA2909NS	Alluminio / Aluminium	Noce Scuro / Dark Walnut	2700	9
TUA2909RA	Alluminio / Aluminium	Rovere Antico / Antique Oak	2700	9
TUA2909RO	Alluminio / Aluminium	Rovere / Oak	2700	9
TUA2909RSP	Alluminio / Aluminium	Rovere Sbiancato Plus Blanched Plus Oak	2700	9
TUA2909TE	Alluminio / Aluminium	Teak	2700	9
TUA2909WE	Alluminio / Aluminium	Wengè	2700	9
TUA2911AC	Alluminio / Aluminium	Acero / Maple	2700	11
TUA2911CI	Alluminio / Aluminium	Ciliegio / Cherry	2700	11
TUA2911CC	Alluminio / Aluminium	Ciliegio Chiaro Light Cherry	2700	11
TUA2911FA	Alluminio / Aluminium	Faggio / Beech	2700	11
TUA2911FS	Alluminio / Aluminium	Faggio Scuro / Dark Beech	2700	11
TUA2911MM	Alluminio / Aluminium	Merbau/Mogano Merbau/Mahogany	2700	11
TUA2911NO	Alluminio / Aluminium	Noce / Walnut	2700	11
TUA2911NS	Alluminio / Aluminium	Noce Scuro / Dark Walnut	2700	11
TUA2911RA	Alluminio / Aluminium	Rovere Antico / Antique Oak	2700	11
TUA2911RO	Alluminio / Aluminium	Rovere / Oak	2700	11
TUA2911RSP	Alluminio / Aluminium	Rovere Sbiancato Plus Blanched Plus Oak	2700	11
TUA2911TE	Alluminio / Aluminium	Teak	2700	11
TUA2911WE	Alluminio / Aluminium	Wengè	2700	11

