



UNYcer®

**Profili per
rivestimenti
in ceramica**

**Profiles
for ceramic
cladding**



UNYcer®

UNYDECO®



UNYcer-LP

Listelli di decoro per rivestimenti in ceramica in molteplici finiture.
Decorative strips for ceramic cladding in multiple finishes.

Profilo Piatto 5x3 Alluminio - Flat profile 5x3 Aluminum

ART.	LEGA ALLOY	FINITURA	FINISH	Lung. mm. Leng. mm.	Misure mm Measure mm
LA53A	Alluminio / Aluminum	Argento	Silver	2400	5x3
LA53ABL	Alluminio / Aluminum	Argento Brillantato Lucido	Silver sparkling polished	2400	5x3
LA53ABS	Alluminio / Aluminum	Argento Brillantato Spazzolato	Silver sparkling brushed	2400	5x3
LA53O	Alluminio / Aluminum	Oro	Gold	2400	5x3
LA53OBL	Alluminio / Aluminum	Oro Brillantato Lucido	Gold polished sparkling	2400	5x3
LA53OBS	Alluminio / Aluminum	Oro Brillantato Spazzolato	Gold polished brushed	2400	5x3
LA53RBL	Alluminio / Aluminum	Rame Brillantato Lucido	Copper sparkling polished	2400	5x3
LA53RBS	Alluminio / Aluminum	Rame Brillantato Spazzolato	Copper sparkling brushed	2400	5x3
LA53TBL	Alluminio / Aluminum	Titanio Brillantato Lucido	Titanium sparkling polished	2400	5x3
LA53TBS	Alluminio / Aluminum	Titanio Brillantato Spazzolato	Titanium sparkling brushed	2400	5x3
LA5391	Alluminio / Aluminum	Bianco Ral 9010	White Ral 9010	2400	5x3
LA53NE	Alluminio / Aluminum	Nero	Black	2400	5x3

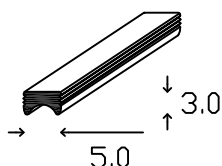

Esempio di posa
Installation example
Scala 1:2

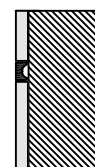

Profilo Piatto 10x3 Alluminio - Flat profile 10x3 Aluminum

ART.	LEGA ALLOY	FINITURA	FINISH	Lung. mm. Leng. mm.	Misure mm Measure mm
LA103A	Alluminio / Aluminum	Argento	Silver	2400	10x3
LA103ABL	Alluminio / Aluminum	Argento Brillantato Lucido	Silver sparkling polished	2400	10x3
LA103ABS	Alluminio / Aluminum	Argento Brillantato Spazzolato	Silver sparkling brushed	2400	10x3
LA103O	Alluminio / Aluminum	Oro	Gold	2400	10x3
LA103OBL	Alluminio / Aluminum	Oro Brillantato Lucido	Gold polished sparkling	2400	10x3
LA103OBS	Alluminio / Aluminum	Oro Brillantato Spazzolato	Gold polished brushed	2400	10x3
LA103RBL	Alluminio / Aluminum	Rame Brillantato Lucido	Copper sparkling polished	2400	10x3
LA103RBS	Alluminio / Aluminum	Rame Brillantato Spazzolato	Copper sparkling brushed	2400	10x3
LA103TBL	Alluminio / Aluminum	Titanio Brillantato Lucido	Titanium sparkling polished	2400	10x3
LA103TBS	Alluminio / Aluminum	Titanio Brillantato Spazzolato	Titanium sparkling brushed	2400	10x3
LA10391	Alluminio / Aluminum	Bianco Ral 9010	White Ral 9010	2400	10x3
LA103NE	Alluminio / Aluminum	Nero	Black	2400	10x3

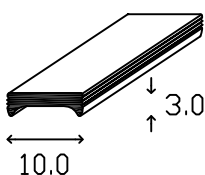

Esempio di posa
Installation example
Scala 1:2

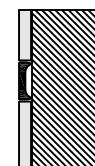

Scala 1:1





UNYcer-LP

Profilo Piatto 10x7 Acciaio Inox - Flat profile 10x7 Stainless steel

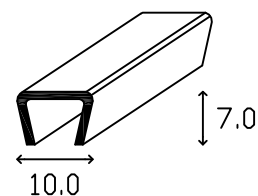
ART.	LEGA ALLOY	FINITURA FINISH	Lung. mm. Leng. mm.	Misure mm Measure mm
LPI107L/304	Acciaio Inox AISI 304 DIN 1.4301 Stainless steel AISI 304 DIN 1.4301	Lucido con protettivo Polished with protective	2700	10x7
LPI107S/304	Acciaio Inox AISI 304 DIN 1.4301 Stainless steel AISI 304 DIN 1.4301	Spazzolato con protettivo Brushed with protective	2700	10x7

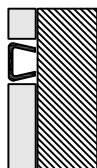

Esempio di posa
Installation example
Scala 1:2



UNYcer-LP

Profilo Piatto 25x7 Acciaio inox - Flat profile 25x7 Stainless steel

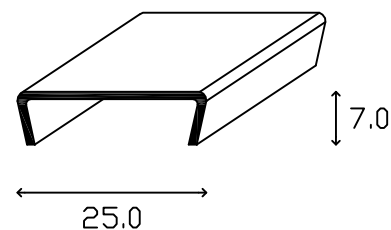
ART.	LEGA ALLOY	FINITURA FINISH	Lung. mm. Leng. mm.	Misure mm Measure mm
LPI257L/304	Acciaio Inox AISI 304 DIN 1.4301 Stainless steel AISI 304 DIN 1.4301	Lucido con protettivo Polished with protective	2700	25x7
LPI257S/304	Acciaio Inox AISI 304 DIN 1.4301 Stainless steel AISI 304 DIN 1.4301	Spazzolato con protettivo Brushed with protective	2700	25x7

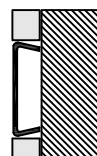

Esempio di posa
Installation example
Scala 1:2



Scala 1:1

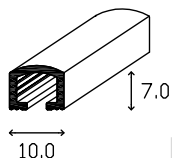

UNYcer-LE Profilo Ellisse 10x7 Alluminio - Oval profile 10x7 Aluminum

ART.	LEGA ALLOY	FINITURA	FINISH	Lung. mm. Leng. mm.	Misure mm Measure mm
LEA107A	Alluminio / Aluminum	Argento	Silver	2700	10x7
LEA107ABL	Alluminio / Aluminum	Argento Brillantato Lucido	Silver sparkling polished	2700	10x7
LEA107ABS	Alluminio / Aluminum	Argento Brillantato Spazzolato	Silver sparkling brushed	2700	10x7
LEA107OBL	Alluminio / Aluminum	Oro Brillantato Lucido	Gold polished sparkling	2700	10x7
LEA107OBS	Alluminio / Aluminum	Oro Brillantato Spazzolato	Gold polished brushed	2700	10x7
LEA107RBL	Alluminio / Aluminum	Rame Brillantato Lucido	Copper sparkling polished	2700	10x7
LEA107RBS	Alluminio / Aluminum	Rame Brillantato Spazzolato	Copper sparkling brushed	2700	10x7
LEA107TBL	Alluminio / Aluminum	Titanio Brillantato Lucido	Titanium sparkling polished	2700	10x7
LEA107TBS	Alluminio / Aluminum	Titanio Brillantato Spazzolato	Titanium sparkling brushed	2700	10x7



Esempio di posa
Installation example

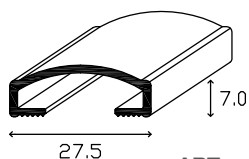

UNYcer-LE Profilo Ellisse 27x7 Alluminio - Oval profile 27x7 Aluminum

ART.	LEGA ALLOY	FINITURA	FINISH	Lung. mm. Leng. mm.	Misure mm Measure mm
LEA277A	Alluminio / Aluminum	Argento	Silver	2700	27x7
LEA277ABL	Alluminio / Aluminum	Argento Brillantato Lucido	Silver sparkling polished	2700	27x7
LEA277ABS	Alluminio / Aluminum	Argento Brillantato Spazzolato	Silver sparkling brushed	2700	27x7
LEA277OBL	Alluminio / Aluminum	Oro Brillantato Lucido	Gold polished sparkling	2700	27x7
LEA277OBS	Alluminio / Aluminum	Oro Brillantato Spazzolato	Gold polished brushed	2700	27x7
LEA277RBL	Alluminio / Aluminum	Rame Brillantato Lucido	Copper sparkling polished	2700	27x7
LEA277RBS	Alluminio / Aluminum	Rame Brillantato Spazzolato	Copper sparkling brushed	2700	27x7
LEA277TBL	Alluminio / Aluminum	Titanio Brillantato Lucido	Titanium sparkling polished	2700	27x7
LEA277TBS	Alluminio / Aluminum	Titanio Brillantato Spazzolato	Titanium sparkling brushed	2700	27x7

Esempio di posa
Installation example

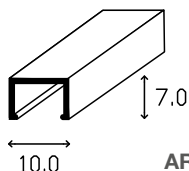

UNYcer-LP Profilo Piatto 10x7 Alluminio - Plate profile 10x7 Aluminum

ART.	LEGA ALLOY	FINITURA	FINISH	Lung. mm. Leng. mm.	Misure mm Measure mm
LPA107A	Alluminio / Aluminum	Argento	Silver	2700	10x7
LPA107ABL	Alluminio / Aluminum	Argento Brillantato Lucido	Silver sparkling polished	2700	10x7
LPA107ABS	Alluminio / Aluminum	Argento Brillantato Spazzolato	Silver sparkling brushed	2700	10x7
LPA107ABSI	Alluminio / Aluminum	Argento Brillantato Spazzolato Incrociato	Crossed Brushed Polished Silver	2700	10x7
LPA107O	Alluminio / Aluminum	Oro	Gold	2700	10x7
LPA107RBL	Alluminio / Aluminum	Rame Brillantato Lucido	Copper sparkling polished	2700	10x7
LPA107RBS	Alluminio / Aluminum	Rame Brillantato Spazzolato	Copper sparkling brushed	2700	10x7
LPA107RBSI	Alluminio / Aluminum	Rame Brillantato Spazzolato Incrociato	Crossed Brushed Polished Copper	2700	10x7
LPA107TBL	Alluminio / Aluminum	Titanio Brillantato Lucido	Titanium sparkling polished	2700	10x7
LPA107TBS	Alluminio / Aluminum	Titanio Brillantato Spazzolato	Titanium sparkling brushed	2700	10x7
LPA107TBSI	Alluminio / Aluminum	Titanio Brillantato Spazzolato Incrociato	Crossed Brushed Polished Titanium	2700	10x7

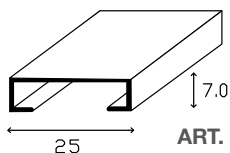

UNYcer-LP Profilo Piatto 25x7 Alluminio - Plate profile 25x7 Aluminum

ART.	LEGA ALLOY	FINITURA	FINISH	Lung. mm. Leng. mm.	Misure mm Measure mm
LPA257A	Alluminio / Aluminum	Argento	Silver	2700	25x7
LPA257ABL	Alluminio / Aluminum	Argento Brillantato Lucido	Silver sparkling polished	2700	25x7
LPA257ABS	Alluminio / Aluminum	Argento Brillantato Spazzolato	Silver sparkling brushed	2700	25x7
LPA257ABSI	Alluminio / Aluminum	Argento Brillantato Spazzolato Incrociato	Crossed Brushed Polished Silver	2700	25x7
LPA257O	Alluminio / Aluminum	Oro	Gold	2700	25x7
LPA257RBL	Alluminio / Aluminum	Rame Brillantato Lucido	Copper sparkling polished	2700	25x7
LPA257RBS	Alluminio / Aluminum	Rame Brillantato Spazzolato	Copper sparkling brushed	2700	25x7
LPA257RBSI	Alluminio / Aluminum	Rame Brillantato Spazzolato Incrociato	Crossed Brushed Polished Copper	2700	25x7
LPA257TBL	Alluminio / Aluminum	Titanio Brillantato Lucido	Titanium sparkling polished	2700	25x7
LPA257TBS	Alluminio / Aluminum	Titanio Brillantato Spazzolato	Titanium sparkling brushed	2700	25x7
LPA257TBSI	Alluminio / Aluminum	Titanio Brillantato Spazzolato Incrociato	Crossed Brushed Polished Titanium	2700	25x7

Profili UNYcer-H-B in alluminio per la decorazione e protezione dei bordi delle piastrelle da urti ed impatti meccanici. Le numerose e nuove finiture e colori permettono molteplici accoppiamenti con i rivestimenti adiacenti.

UNYcer-H-B aluminum profiles for the decoration and protection of tile edges from shocks and mechanical impacts. The numerous new finishes and colors allow multiple combinations with adjacent coverings.

Le basi dei profili vengono fornite con apposita tranciatura e foratura per una più rapida ed efficace posa in opera dei profili sotto al rivestimento piastrellato.

The base of the profiles is supplied punched and drilled for a quicker and more efficient installation of the profiles under the tiled cladding.

UNYcer-H-B

Profili per pavimenti e rivestimenti in ceramica per bassi spessori
Profiles for low thickness ceramic floors and coverings

Lunghezza barre 2700mm
Bar length 2700mm

ART.	LEGA ALLOY	FINITURA FINISH	COLORE COLOUR	H mm
GSA3023A	Alluminio / Aluminum	Argento / Silver		3
GSA3023A-C	Alluminio / Aluminum	Argento / Silver		3
GSA3023ABL	Alluminio / Aluminum	Argento Brillantato Lucido Silver sparkling polished		3
GSA3023TBL	Alluminio / Aluminum	Titanio Brillantato Lucido Titanium sparkling polished		3
GSA302391	Alluminio / Aluminum	Bianco Ral 9010 White Ral 9010		3

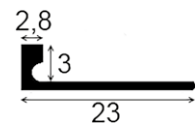

Lunghezza barre 2700mm
Bar length 2700mm

ART.	LEGA ALLOY	FINITURA FINISH	COLORE COLOUR	H mm
GSA4523A	Alluminio / Aluminum	Argento / Silver		4,5
GSA4523A-C	Alluminio / Aluminum	Argento / Silver		4,5
GSA4523ABL	Alluminio / Aluminum	Argento Brillantato Lucido Silver sparkling polished		4,5
GSA4523TBL	Alluminio / Aluminum	Titanio Brillantato Lucido Titanium sparkling polished		4,5
GSA452391	Alluminio / Aluminum	Bianco Ral 9010 White Ral 9010		4,5

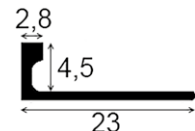

Profili curvabili e/o sagomabili manualmente o con macchina Unymac (vedi pagina 345)
Bendable profiles shaped manually or by the Unymac calender machine (see page 345)

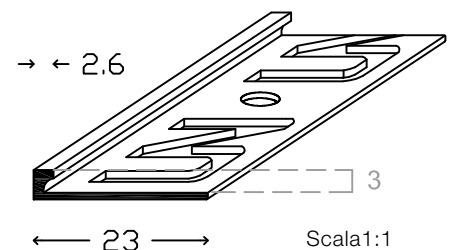

Esempio di posa
Installation example

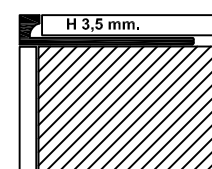

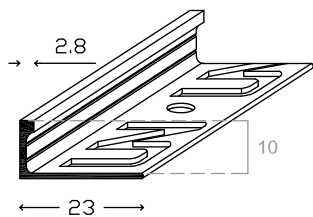

UNYcer®-H-B

Profili per rivestimenti in ceramica - Profiles for ceramic cladding

Lunghezza barre 2700mm / Bar length 2700mm

ART.	LEGA ALLOY	FINITURA FINISH	COLORE COLOUR	H mm
GSA6023A	Alluminio / Aluminum	Argento / Silver		6
GSA6023A-C	Alluminio / Aluminum	Argento / Silver		6
GSA6023ABL	Alluminio / Aluminum	Argento Brillantato Lucido Silver sparkling polished		6
GSA6023ABS	Alluminio / Aluminum	Argento Brillantato Spazzolato Silver sparkling brushed		6
GSA6023NEO	Alluminio / Aluminum	Nero opaco anodizzato / Anodized matt black		6
GSA6023BI	Alluminio / Aluminum	Bianco Ral 9003/ White Ral 9003		6
GSA6023TBL	Alluminio / Aluminum	Titanio Brillantato Lucido Titanium sparkling polished		6
GSA6023TS	Alluminio / Aluminum	Titanio Satinato / Satin Titanium		6
GSA602391	Alluminio / Aluminum	Bianco Ral 9010 / White ral 9010		6

NEW!
NEW!

NEW!

Lunghezza barre 2700mm / Bar length 2700mm

ART.	LEGA ALLOY	FINITURA FINISH	COLORE COLOUR	H mm
GSA8023A	Alluminio / Aluminum	Argento / Silver		8
GSA8023A-C	Alluminio / Aluminum	Argento / Silver		8
GSA8023ABL	Alluminio / Aluminum	Argento Brillantato Lucido Silver sparkling polished		8
GSA8023ABS	Alluminio / Aluminum	Argento Brillantato Spazzolato Silver sparkling brushed		8
GSA8023BI	Alluminio / Aluminum	Bianco Ral 9003 / White ral 9003		8
GSA8023NEO	Alluminio / Aluminum	Nero opaco anodizzato / Anodized matt black		8
GSA8023O	Alluminio / Aluminum	Oro Satinato / Satin Gold		8
GSA8023TBL	Alluminio / Aluminum	Titanio Brillantato Lucido Titanium sparkling polished		8
GSA8023TS	Alluminio / Aluminum	Titanio Satinato / Satin Titanium		8
GSA802391	Alluminio / Aluminum	Bianco Ral 9010 / White Ral 9010		8
GSO8023EN	Ottone / Brass	Naturale / Natural		8
GSO8023C	Ottone / Brass	Cromato Lucido / Chromed Sparkling		8

NEW!
NEW!
NEW!

NEW!

Lunghezza barre 2700mm / Bar length 2700mm

ART.	LEGA ALLOY	FINITURA FINISH	COLORE COLOUR	H mm
GSA10023A	Alluminio / Aluminum	Argento / Silver		10
GSA10023A-C	Alluminio / Aluminum	Argento / Silver		10
GSA10023ABL	Alluminio / Aluminum	Argento Brillantato Lucido Silver sparkling polished		10
GSA10023ABL-C	Alluminio / Aluminum	Argento Brillantato Lucido Silver sparkling polished		10
GSA10023ABS	Alluminio / Aluminum	Argento Brillantato Spazzolato Silver sparkling brushed		10
GSA10023ABS-C	Alluminio / Aluminum	Argento Brillantato Spazzolato Silver sparkling brushed		10
GSA10023BI	Alluminio / Aluminum	Bianco Ral 9003 / White ral 9003		10
GSA10023NEO	Alluminio / Aluminum	Nero opaco anodizzato / Anodized matt black		10
GSA10023NBS ALL	Alluminio / Aluminum	Nero Brillantato Spazzolato / Brushed Gloss Black		10
GSA10023O	Alluminio / Aluminum	Oro Satinato / Satin Gold		10
GSA10023OBL	Alluminio / Aluminum	Oro Brillantato Lucido Oro sparkling polished		10
GSA10023OBS	Alluminio / Aluminum	Oro Brillantato Spazzolato Oro sparkling Brushed		10
GSA10023RBS	Alluminio / Aluminum	Rame Brillantato Spazzolato Copper sparkling brushed		10
GSA10023TBL	Alluminio / Aluminum	Titanio Brillantato Lucido Titanium sparkling polished		10
GSA10023TS	Alluminio / Aluminum	Titanio Satinato / Satin Titanium		10
GSA1002391	Alluminio / Aluminum	Bianco Ral 9010 / White ral 9010		10
GSO10023EN	Ottone / Brass	Naturale / Natural		10
GSO10023C	Ottone / Brass	Cromato Lucido / Chromed Sparkling		10

NEW!

NEW!

NEW!

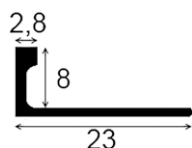
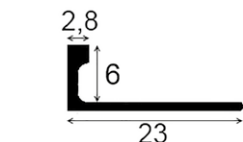

☒ Profili curvabili e/o sagomabili manualmente o con macchina Unymac (vedi pagina 369)
Bendable profiles shaped manually or by the Unymac calender machine (see page 369)

UNYcer®-H-B

Lunghezza barre 2700mm / Bar length 2700mm

ART.	LEGA ALLOY	FINITURA FINISH	COLORE COLOUR	H mm
GSA11023A	Alluminio / Aluminum	Argento / Silver		11
GSA11023ABL	Alluminio / Aluminum	Argento Brillantato Lucido Silver sparkling polished		11
GSA11023ABS	Alluminio / Aluminum	Argento Brillantato Spazzolato Silver sparkling brushed		11
GSA11023BI	Alluminio / Aluminum	Bianco Ral 9003 / White ral 9003		11
GSA11023NEO	Alluminio / Aluminum	Nero opaco anodizzato Anodized matt black		11
GSA11023NBS	Alluminio / Aluminum	Nero Brillantato Spazzolato Black sparkling brushed		11
GSA11023TS	Alluminio / Aluminum	Titanio Satinato / Satin Titanium		11
GSA1102391	Alluminio / Aluminum	Bianco Ral 9010 / White ral 9010		11

NEW!

NEW!

NEW!

NEW!

NEW!

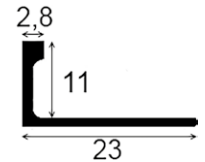

Lunghezza barre 2700mm / Bar length 2700mm

ART.	LEGA ALLOY	FINITURA FINISH	COLORE COLOUR	H mm
GSA12523A	Alluminio / Aluminum	Argento / Silver		12,5
GSA12523A-C	Alluminio / Aluminum	Argento / Silver		12,5
GSA12523ABL	Alluminio / Aluminum	Argento Brillantato Lucido Silver sparkling polished		12,5
GSA12523ABL-C	Alluminio / Aluminum	Argento Brillantato Lucido Silver sparkling polished		12,5
GSA12523ABS	Alluminio / Aluminum	Argento Brillantato Spazzolato Silver sparkling brushed		12,5
GSA12523BI	Alluminio / Aluminum	Bianco Ral 9003 / White ral 9003		12,5
GSA12523NEO	Alluminio / Aluminum	Nero opaco anodizzato / Anodized matt black		12,5
GSA12523TBL	Alluminio / Aluminum	Titanio Brillantato Lucido Titanium sparkling polished		12,5
GSA12523TS	Alluminio / Aluminum	Titanio Satinato / Satin Titanium		12,5
GSA1252391	Alluminio / Aluminum	Bianco Ral 9010 / White ral 9010		12,5
GSO12523EN	Ottone / Brass	Naturale / Natural		12
GSO12523C	Ottone / Brass	Cromato Lucido / Chromed Sparkling		12

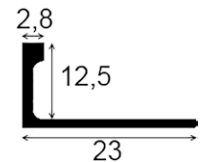

Lunghezza barre 2700mm / Bar length 2700mm

ART.	LEGA ALLOY	FINITURA FINISH	COLORE COLOUR	H mm
GSA15023A	Alluminio / Aluminum	Argento / Silver		15
GSA15023A-C	Alluminio / Aluminum	Argento / Silver		15
GSA15023ABL	Alluminio / Aluminum	Argento Brillantato Lucido Silver sparkling polished		15
GSA15023ABL-C	Alluminio / Aluminum	Argento Brillantato Lucido Silver sparkling polished		15
GSA15023ABS	Alluminio / Aluminum	Argento Brillantato Spazzolato Silver sparkling brushed		15
GSA15023ABS-C	Alluminio / Aluminum	Argento Brillantato Spazzolato Silver sparkling brushed		15
GSA12523BI	Alluminio / Aluminum	Bianco Ral 9003 / White ral 9003		15
GSA15023NEO	Alluminio / Aluminum	Nero opaco anodizzato / Anodized matt black		15
GSA1502391	Alluminio / Aluminum	Bianco Ral 9010 / White ral 9010		15
GSO15023EN	Ottone / Brass	Naturale / Natural		15
GSO15023C	Ottone / Brass	Cromato Lucido / Chromed Sparkling		15

NEW!

NEW!

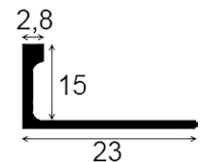

Lunghezza barre 2700mm / Bar length 2700mm

ART.	LEGA ALLOY	FINITURA FINISH	COLORE COLOUR	H mm
GSA20023A	Alluminio / Aluminum	Argento / Silver		20

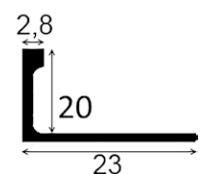

Profili curvabili e/o sagomabili manualmente o con macchina Unymac (vedi pagina 369)
Bendable profiles shaped manually or by the Unymac calender machine (see page 369)



UNYcer®-H-B UNYCER-H-B linea PIETRA
UNYCER-H-B STONE line profiles

NEW!

UNYcer-H-B pietra sono 12 nuove colorazioni in alluminio verniciato smaltato con polvere epossidica, ricreano al tatto l' effetto Pietra. Le diverse tonalità dal bianco al nero ai colori sabbia si abbinano alle colorazioni di tendenza, senza rinunciare a un prodotto di alta qualità.

UNYcer-H-B stone are 12 new colors in painted aluminum enamelled with epoxy powder, they recreate the stone effect to the touch. The different shades from white to black to sand colors match the trendy colors, without giving up a high quality product.

Lunghezza barre 2700mm / Bar length 2700mm

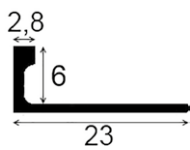

ART.	LEGA ALLOY	FINITURA FINISH	COLORE COLOUR	H mm
GSA6023PGRC	Alluminio / Aluminum	Pietra grigio chiaro / Light grey stone		6
GSA6023PGR	Alluminio / Aluminum	Pietra grigio / Grey stone		6
GSA6023PGRA	Alluminio / Aluminum	Pietra grigia antico / Ancient grey stone		6
GSA6023GA	Alluminio / Aluminum	Pietra grigio antracite / Anthracite grey stone		6
GSA6023GAS	Alluminio / Aluminum	Pietra grigio antracite scuro Dark anthracite grey stone		6
GSA6023PAG	Alluminio / Aluminum	Pietra avorio grigio / Grey ivory stone		6
GSA6023PBC	Alluminio / Aluminum	Pietra beige chiaro / Light beige stone		6
GSA6023PBA	Alluminio / Aluminum	Pietra beige antico / Antique beige stone		6
GSA6023PBM	Alluminio / Aluminum	Pietra beige marrone / Brown beige stone		6
GSA6023PCA	Alluminio / Aluminum	Pietra corten antico / Ancient corten stone		6
GSA6023PNEO	Alluminio / Aluminum	Pietra nero opaco / Matt black stone		6
GSA6023PBIO	Alluminio / Aluminum	Pietra bianco opaco / Matt white stone		6

Lunghezza barre 2700mm / Bar length 2700mm

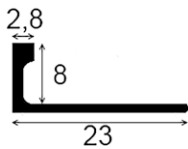

ART.	LEGA ALLOY	FINITURA FINISH	COLORE COLOUR	H mm
GSA8023PGRC	Alluminio / Aluminum	Pietra grigio chiaro / Light grey stone		8
GSA8023PGR	Alluminio / Aluminum	Pietra grigio / Grey stone		8
GSA8023PGRA	Alluminio / Aluminum	Pietra grigia antico / Ancient grey stone		8
GSA8023GA	Alluminio / Aluminum	Pietra grigio antracite / Anthracite grey stone		8
GSA8023GAS	Alluminio / Aluminum	Pietra grigio antracite scuro Dark anthracite grey stone		8
GSA8023PAG	Alluminio / Aluminum	Pietra avorio grigio / Grey ivory stone		8
GSA8023PBC	Alluminio / Aluminum	Pietra beige chiaro / Light beige stone		8
GSA8023PBA	Alluminio / Aluminum	Pietra beige antico / Antique beige stone		8
GSA8023PBM	Alluminio / Aluminum	Pietra beige marrone / Brown beige stone		8
GSA8023PCA	Alluminio / Aluminum	Pietra corten antico / Ancient corten stone		8
GSA8023PNEO	Alluminio / Aluminum	Pietra nero opaco / Matt black stone		8
GSA8023PBIO	Alluminio / Aluminum	Pietra bianco opaco / Matt white stone		8

Lunghezza barre 2700mm / Bar length 2700mm

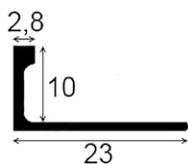

ART.	LEGA ALLOY	FINITURA FINISH	COLORE COLOUR	H mm
GSA10023PGRC	Alluminio / Aluminum	Pietra grigio chiaro / Light grey stone		10
GSA10023PGR	Alluminio / Aluminum	Pietra grigio / Grey stone		10
GSA10023PGRA	Alluminio / Aluminum	Pietra grigia antico / Ancient grey stone		10
GSA10023GA	Alluminio / Aluminum	Pietra grigio antracite / Anthracite grey stone		10
GSA10023GAS	Alluminio / Aluminum	Pietra grigio antracite scuro Dark anthracite grey stone		10
GSA10023PAG	Alluminio / Aluminum	Pietra avorio grigio / Grey ivory stone		10
GSA10023PBC	Alluminio / Aluminum	Pietra beige chiaro / Light beige stone		10
GSA10023PBA	Alluminio / Aluminum	Pietra beige antico / Antique beige stone		10
GSA10023PBM	Alluminio / Aluminum	Pietra beige marrone / Brown beige stone		10
GSA10023PCA	Alluminio / Aluminum	Pietra corten antico / Ancient corten stone		10
GSA10023PNEO	Alluminio / Aluminum	Pietra nero opaco / Matt black stone		10
GSA10023PBIO	Alluminio / Aluminum	Pietra bianco opaco / Matt white stone		10

Lunghezza barre 2700mm / Bar length 2700mm

ART.	LEGA ALLOY	FINITURA FINISH	COLORE COLOUR	H mm
GSA11023PGRC	Alluminio / Aluminum	Pietra grigio chiaro / Light grey stone		11
GSA11023PGR	Alluminio / Aluminum	Pietra grigio / Grey stone		11
GSA11023PGRA	Alluminio / Aluminum	Pietra grigia antico / Ancient grey stone		11
GSA11023GA	Alluminio / Aluminum	Pietra grigio antracite / Anthracite grey stone		11
GSA11023GAS	Alluminio / Aluminum	Pietra grigio antracite scuro Dark anthracite grey stone		11
GSA11023PAG	Alluminio / Aluminum	Pietra avorio grigio / Grey ivory stone		11
GSA11023PBC	Alluminio / Aluminum	Pietra beige chiaro / Light beige stone		11
GSA11023PBA	Alluminio / Aluminum	Pietra beige antico / Antique beige stone		11
GSA11023PBM	Alluminio / Aluminum	Pietra beige marrone / Brown beige stone		11
GSA11023PCA	Alluminio / Aluminum	Pietra corten antico / Ancient corten stone		11
GSA11023PNEO	Alluminio / Aluminum	Pietra nero opaco / Matt black stone		11
GSA11023PBIO	Alluminio / Aluminum	Pietra bianco opaco / Matt white stone		11

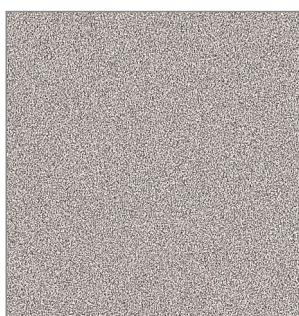
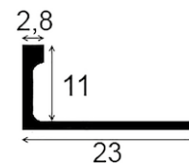

GRIGIO ANTICO
ANCIENT GRAY

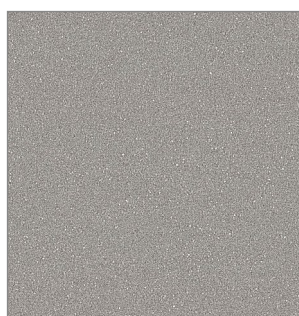

GRIGIO
GRAY

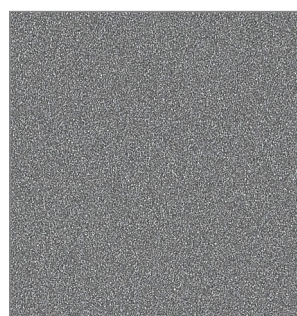

GRIGIO ANTRACITE
ANTHRACITE GRAY

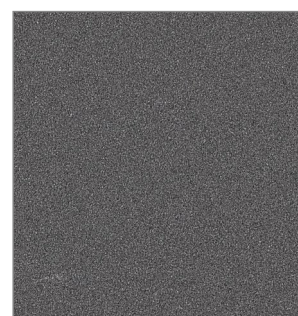

ANTRACITE SCURO
DARK ANTHRACITE GRAY



AVORIO GRIGIO
IVORY GRAY



BEIGE CHIARO
LIGHT BEIGE



BEIGE ANTICO
ANCIENT BEIGE

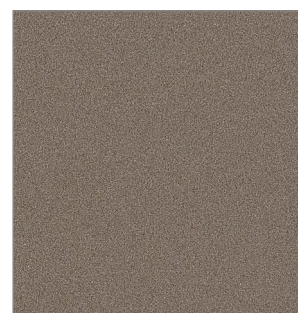

BEIGE MARRONE
BEIGE BROWN



CORTEN ANTICO
ANCIENT CORTEN



GRIGIO CHIARO
LIGHT GREY

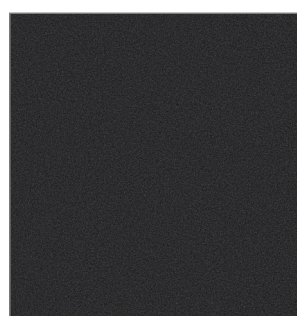

NERO OPACO
MATT BLACK

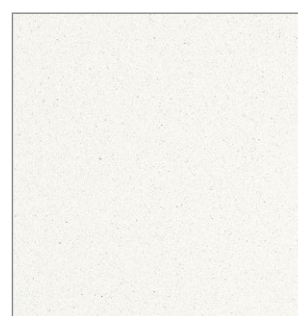

BIANCO OPACO
MATT WHITE

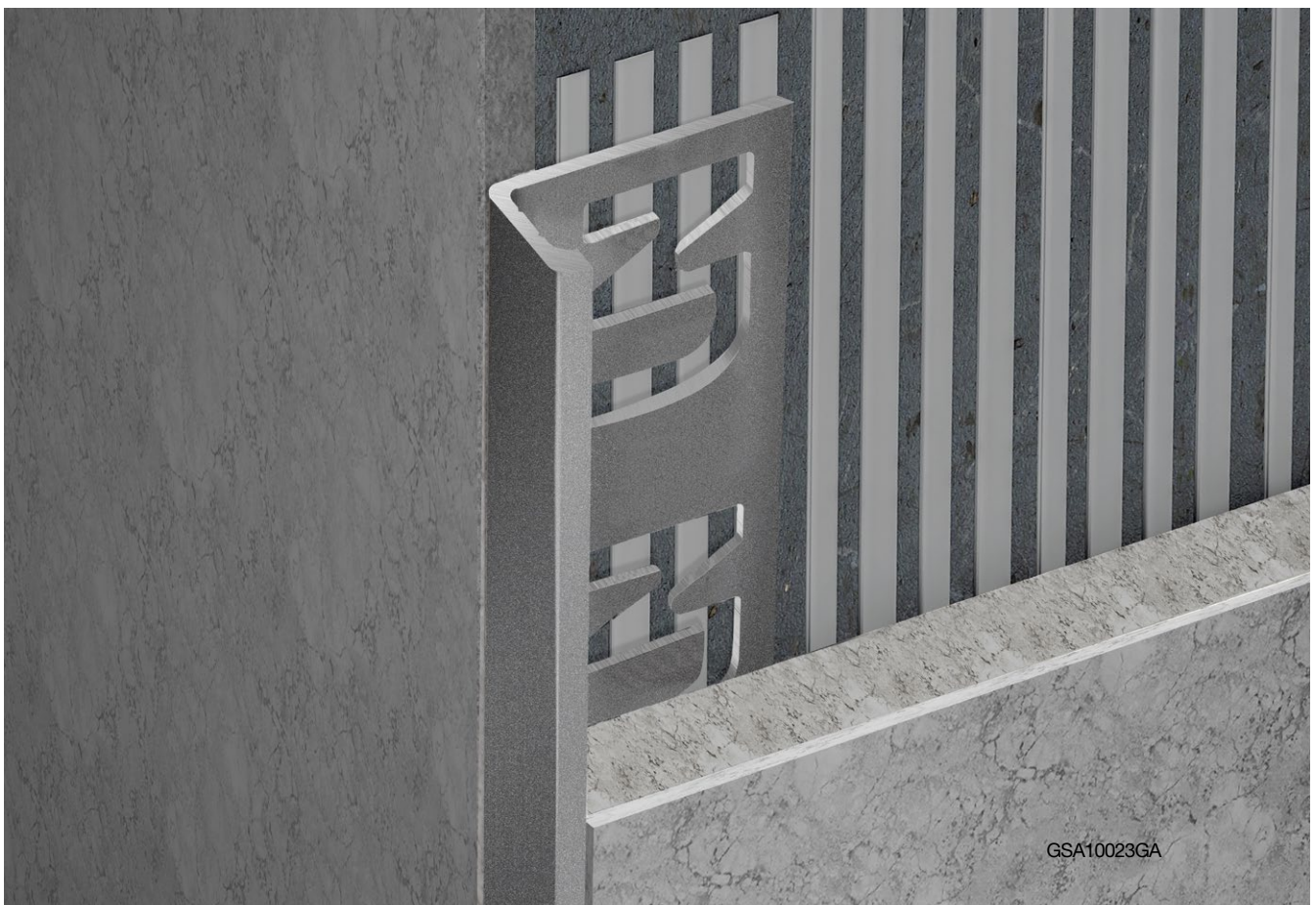

Profili in acciaio per la protezione dei bordi delle piastrelle da urti ed impatti meccanici, con base ad incastro. Vengono impiegati anche come elemento finale di finitura di battiscopa in ceramica o legno (Dualwood) o per rivestimenti di bagni e cucine; le numerose e nuove finiture e colori permettono molteplici accoppiamenti con i rivestimenti adiacenti.

Profiles in stainless steel to protect the edges of tiles from shocks and mechanical impacts with interlocking base. They can also be used as final finishing elements for ceramic and wood skirting (Dualwood) or for cladding in the bathroom and kitchen; the numerous and new finishes and colours allow for multiple matching with adjacent cladding.

Le basi dei profili vengono fornite con apposita tranciatura e foratura per una più rapida ed efficace posa in opera dei profili sotto al rivestimento piastrellato.

The base of the profiles is supplied punched and drilled for a quicker and more efficient installation of the profiles under the tiled cladding.

UNYcer®-H-B Profili per rivestimenti in ceramica - Profiles for ceramic cladding

Lunghezza barre 2700mm / Bar length 2700mm

ART.	LEGA ALLOY	FINITURA FINISH	COLORE COLOUR	H mm
GSI3023L/304	Acciaio Inox AISI 304 DIN 1.4301 Stainless steel AISI 304 DIN 1.4301	Lucido con protettivo Polished with protective		3
GSI3023L/304-C	Acciaio Inox AISI 304 DIN 1.4301 Stainless steel AISI 304 DIN 1.4301	Lucido con protettivo Polished with protective		3
GSI3023S/304	Acciaio Inox AISI 304 DIN 1.4301 Stainless steel AISI 304 DIN 1.4301	Spazzolato con protettivo Brushed with protective		3

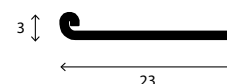

Lunghezza barre 2700mm / Bar length 2700mm

ART.	LEGA ALLOY	FINITURA FINISH	COLORE COLOUR	H mm
GSI4523L/304	Acciaio Inox AISI 304 DIN 1.4301 Stainless steel AISI 304 DIN 1.4301	Lucido con protettivo Polished with protective		4,5
GSI4523L/304-C	Acciaio Inox AISI 304 DIN 1.4301 Stainless steel AISI 304 DIN 1.4301	Lucido con protettivo Polished with protective		4,5
GSI4523S/304	Acciaio Inox AISI 304 DIN 1.4301 Stainless steel AISI 304 DIN 1.4301	Spazzolato con protettivo Brushed with protective		4,5



Lunghezza barre 2700mm / Bar length 2700mm

ART.	LEGA ALLOY	FINITURA FINISH	COLORE COLOUR	H mm
GSI6023L/304	Acciaio Inox AISI 304 DIN 1.4301 Stainless steel AISI 304 DIN 1.4301	Lucido con protettivo Polished with protective		6
GSI6023L/304-C	Acciaio Inox AISI 304 DIN 1.4301 Stainless steel AISI 304 DIN 1.4301	Lucido con protettivo Polished with protective		6
GSI6023S/304	Acciaio Inox AISI 304 DIN 1.4301 Stainless steel AISI 304 DIN 1.4301	Spazzolato con protettivo Brushed with protective		6
GSI6023S/304-C	Acciaio Inox AISI 304 DIN 1.4301 Stainless steel AISI 304 DIN 1.4301	Spazzolato con protettivo Brushed with protective		6







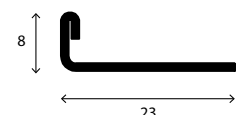

Lunghezza barre 2700mm / Bar length 2700mm

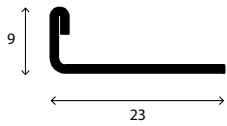
ART.	LEGA ALLOY	FINITURA FINISH	COLORE COLOUR	H mm
GSI8023L/304	Acciaio Inox AISI 304 DIN 1.4301 Stainless steel AISI 304 DIN 1.4301	Lucido con protettivo Polished with protective		8
GSI8023L/304-C	Acciaio Inox AISI 304 DIN 1.4301 Stainless steel AISI 304 DIN 1.4301	Lucido con protettivo Polished with protective		8
GSI8023S/304	Acciaio Inox AISI 304 DIN 1.4301 Stainless steel AISI 304 DIN 1.4301	Spazzolato con protettivo Brushed with protective		8
GSI8023S/304-C	Acciaio Inox AISI 304 DIN 1.4301 Stainless steel AISI 304 DIN 1.4301	Spazzolato con protettivo Brushed with protective		8









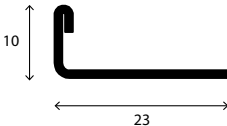

Lunghezza barre 2700mm / Bar length 2700mm



ART.	LEGA ALLOY	FINITURA FINISH	COLORE COLOUR	H mm
GSI9023L/304	Acciaio Inox AISI 304 DIN 1.4301 Stainless steel AISI 304 DIN 1.4301	Lucido con protettivo Polished with protective		9
 GSI9023L/304-C	Acciaio Inox AISI 304 DIN 1.4301 Stainless steel AISI 304 DIN 1.4301	Lucido con protettivo Polished with protective		9
GSI9023S/304	Acciaio Inox AISI 304 DIN 1.4301 Stainless steel AISI 304 DIN 1.4301	Spazzolato con protettivo Brushed with protective		9
 GSI9023S/304-C	Acciaio Inox AISI 304 DIN 1.4301 Stainless steel AISI 304 DIN 1.4301	Spazzolato con protettivo Brushed with protective		9

Lunghezza barre 2700mm / Bar length 2700mm



ART.	LEGA ALLOY	FINITURA FINISH	COLORE COLOUR	H mm
GSI10023L/304	Acciaio Inox AISI 304 DIN 1.4301 Stainless steel AISI 304 DIN 1.4301	Lucido con protettivo Polished with protective		10
 GSI10023L/304-C	Acciaio Inox AISI 304 DIN 1.4301 Stainless steel AISI 304 DIN 1.4301	Lucido con protettivo Polished with protective		10
GSI10023S/304	Acciaio Inox AISI 304 DIN 1.4301 Stainless steel AISI 304 DIN 1.4301	Spazzolato con protettivo Brushed with protective		10
 GSI10023S/304-C	Acciaio Inox AISI 304 DIN 1.4301 Stainless steel AISI 304 DIN 1.4301	Spazzolato con protettivo Brushed with protective		10
GSI10023L/316	Acciaio Inox AISI 316 DIN 14401* Stainless steel AISI 316 DIN 14401*	Lucido con protettivo Polished with protective		10
GSI10023S/316	Acciaio Inox AISI 316 DIN 14401* Stainless steel AISI 316 DIN 14401*	Spazzolato con protettivo Brushed with protective		10





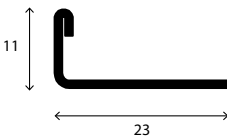

NEW!

NEW!

*AISI316 Specifico per ambienti marini e piscine
AISI316 Specifically designed for marine environments and swimming pools







Lunghezza barre 2700mm / Bar length 2700mm

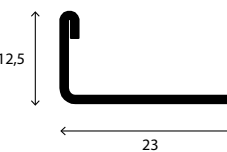

ART.	LEGA ALLOY	FINITURA FINISH	COLORE COLOUR	H mm
GSI11023L/304	Acciaio Inox AISI 304 DIN 1.4301 Stainless steel AISI 304 DIN 1.4301	Lucido con protettivo Polished with protective		11
 GSI11023L/304-C	Acciaio Inox AISI 304 DIN 1.4301 Stainless steel AISI 304 DIN 1.4301	Lucido con protettivo Polished with protective		11
GSI11023S/304	Acciaio Inox AISI 304 DIN 1.4301 Stainless steel AISI 304 DIN 1.4301	Spazzolato con protettivo Brushed with protective		11
 GSI11023S/304-C	Acciaio Inox AISI 304 DIN 1.4301 Stainless steel AISI 304 DIN 1.4301	Spazzolato con protettivo Brushed with protective		11

Lunghezza barre 2700mm / Bar length 2700mm



ART.	LEGA ALLOY	FINITURA FINISH	COLORE COLOUR	H mm
GSI12523L/304	Acciaio Inox AISI 304 DIN 1.4301 Stainless steel AISI 304 DIN 1.4301	Lucido con protettivo Polished with protective		12,5
 GSI12523L/304-C	Acciaio Inox AISI 304 DIN 1.4301 Stainless steel AISI 304 DIN 1.4301	Lucido con protettivo Polished with protective		12,5
GSI12523S/304	Acciaio Inox AISI 304 DIN 1.4301 Stainless steel AISI 304 DIN 1.4301	Spazzolato con protettivo Brushed with protective		12,5
 GSI12523S/304-C	Acciaio Inox AISI 304 DIN 1.4301 Stainless steel AISI 304 DIN 1.4301	Spazzolato con protettivo Brushed with protective		12,5

Lunghezza barre 2700mm / Bar length 2700mm

ART.	LEGA ALLOY	FINITURA FINISH	COLORE COLOUR	H mm
GSI15023L/304	Acciaio Inox AISI 304 DIN 1.4301 Stainless steel AISI 304 DIN 1.4301	Lucido con protettivo Polished with protective		15
GSI15023L/304-C	Acciaio Inox AISI 304 DIN 1.4301 Stainless steel AISI 304 DIN 1.4301	Lucido con protettivo Polished with protective		15
GSI15023S/304	Acciaio Inox AISI 304 DIN 1.4301 Stainless steel AISI 304 DIN 1.4301	Spazzolato con protettivo Brushed with protective		15
GSI15023S/304-C	Acciaio Inox AISI 304 DIN 1.4301 Stainless steel AISI 304 DIN 1.4301	Spazzolato con protettivo Brushed with protective		15

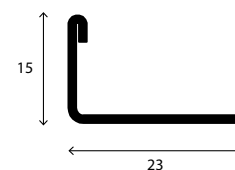

ART.	LEGA ALLOY	FINITURA FINISH	COLORE COLOUR	H mm
GSI20023L/304	Acciaio Inox AISI 304 DIN 1.4301 Stainless steel AISI 304 DIN 1.4301	Lucido con protettivo Polished with protective		20
GSI20023S/304	Acciaio Inox AISI 304 DIN 1.4301 Stainless steel AISI 304 DIN 1.4301	Spazzolato con protettivo Brushed with protective		20

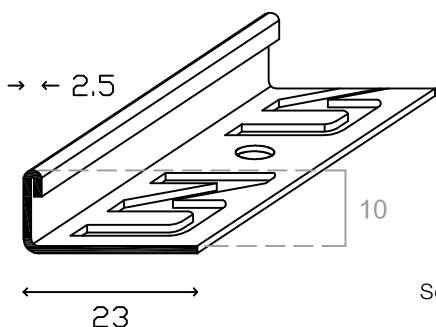
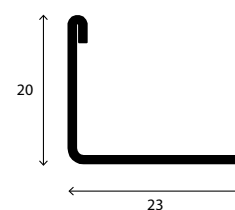

Scala 1:1

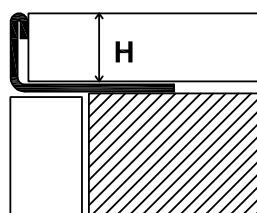

Esempio di posa
Installation example

Le basi dei profili vengono fornite con apposita tranciatura e foratura per una più rapida ed efficace posa in opera dei profili sotto al rivestimento piastrellato.

The base of the profiles is supplied punched and drilled for a quicker and more efficient installation of the profiles under the tiled cladding.

Profili jolly in alluminio per la protezione degli angoli esterni delle piastrelle con base ad incastro. La caratteristica sagoma quadra permette molteplici realizzazioni e finiture di completamento.

Jolly profiles in aluminum for the protection of external corners of tiles with interlocking bases. The characteristic square shape allows numerous creations and finishing.

UNYcer®-HQ-B

Profilo con base ad incastro per bassi spessori
Profiles with interlocking base for low thicknesses

Lunghezza barre 2700mm / Bar length 2700mm

ART.	LEGA ALLOY	FINITURA FINISH	COLORE COLOUR	H mm
GSQA4526A	Alluminio / Aluminum	Argento / Silver		4,5
GSQA4526ABL	Alluminio / Aluminum	Argento Brillantato Lucido Silver sparkling polished		4,5
GSQA4526ABS	Alluminio / Aluminum	Argento Brillantato Spazzolato Silver sparkling brushed		4,5
GSQA4526RBL	Alluminio / Aluminum	Rame Brillantato Lucido Copper sparkling polished		4,5
GSQA4526RBS	Alluminio / Aluminum	Rame Brillantato Spazzolato Copper sparkling brushed		4,5
GSQA4526TBL	Alluminio / Aluminum	Titanio Brillantato Lucido Titanium sparkling polished		4,5
GSQA4526TBS	Alluminio / Aluminum	Titanio Brillantato Spazzolato Titanium sparkling brushed		4,5
GSQA452691	Alluminio / Aluminum	Bianco Ral 9010 / White ral 9010		4,5

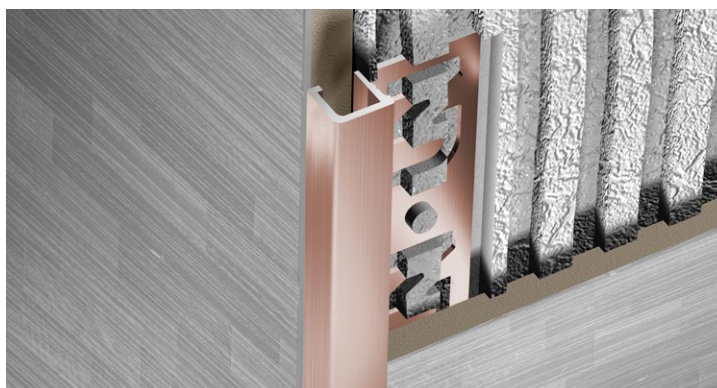
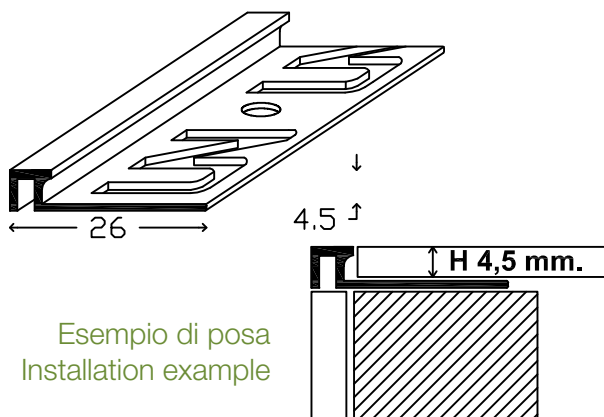

Lunghezza barre 2700mm / Bar length 2700mm

ART.	LEGA ALLOY	FINITURA FINISH	COLORE COLOUR	H mm
GSQA6027A	Alluminio / Aluminum	Argento / Silver		6
GSQA6027ABL	Alluminio / Aluminum	Argento Brillantato Lucido Silver sparkling polished		6
GSQA6027ABS	Alluminio / Aluminum	Argento Brillantato Spazzolato Silver sparkling brushed		6
GSQA6027RBL	Alluminio / Aluminum	Rame Brillantato Lucido Copper sparkling polished		6
GSQA6027RBS	Alluminio / Aluminum	Rame Brillantato Spazzolato Copper sparkling brushed		6
GSQA6027TS	Alluminio / Aluminum	Titanio Satinato / Titanium Frosted		6
GSQA602791	Alluminio / Aluminum	Bianco Ral 9010 / White ral 9010		6

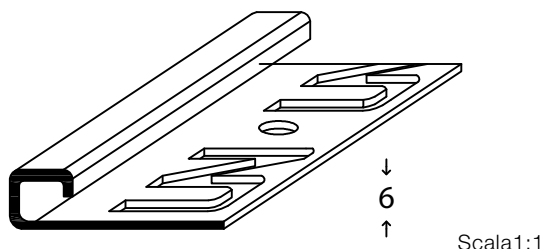

Esempio di posa
Installation example

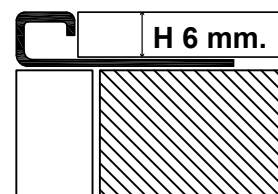

UNYcer-HQ-B Profili con base ad incastro - Profiles with interlocking base

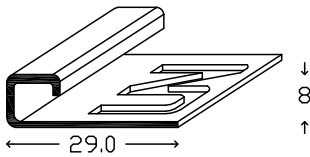

Esempio di posa
Installation example

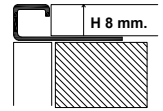

Lunghezza barre 2700mm / Bar length 2700mm

ART.	LEGA ALLOY	FINITURA	FINISH	COLORE COLOUR	H mm
GSQA8029A	Alluminio / Aluminum	Argento	Silver		8
GSQA8029ABL	Alluminio / Aluminum	Argento Brillantato Lucido	Silver sparkling polished		8
GSQA8029ABS	Alluminio / Aluminum	Argento Brillantato Spazzolato	Silver sparkling brushed		8
GSQA8029RBL	Alluminio / Aluminum	Rame Brillantato Lucido	Copper sparkling polished		8
GSQA8029RBS	Alluminio / Aluminum	Rame Brillantato Spazzolato	Copper sparkling brushed		8
GSQA8029TBL	Alluminio / Aluminum	Titanio Brillantato Lucido	Titanium sparkling polished		8
GSQA8029TBS	Alluminio / Aluminum	Titanio Brillantato Spazzolato	Titanium sparkling brushed		8
GSQA8029TS	Alluminio / Aluminum	Titanio Satinato	Titanium frosted		8
GSQA802991	Alluminio / Aluminum	Bianco Ral 9010	White RAL 9010		8
GSQA8029GA	Alluminio / Aluminum	Grigio Antracite	Grey Anthracite		8
GSQA8029NEO	Alluminio / Aluminum	Nero opaco	Matt Black		8
GSQA8029NBS	Alluminio / Aluminum	Nero Brillantato Spazzolato	Black sparkling brushed		8

NEW!

NEW!

NEW!

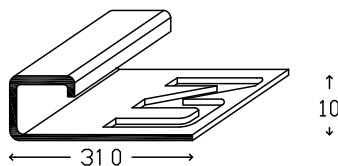

Esempio di posa
Installation example

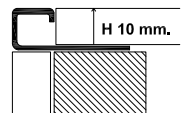

Lunghezza barre 2700mm / Bar length 2700mm

GSQA10031A	Alluminio / Aluminum	Argento	Silver		10
GSQA10031ABL	Alluminio / Aluminum	Argento Brillantato Lucido	Silver sparkling polished		10
GSQA10031ABS	Alluminio / Aluminum	Argento Brillantato Spazzolato	Silver sparkling brushed		10
GSQA10031ASI	Alluminio / Aluminum	Argento Spazzolato Incrociato	Silver cross brushed		10
GSQA10031B	Alluminio / Aluminum	Bronzo	Bronze		10
GSQA10031RBL	Alluminio / Aluminum	Rame Brillantato Lucido	Copper sparkling polished		10
GSQA10031BI	Alluminio / Aluminum	Bianco Ral 9003	White ral 9003		10
GSQA10031RBS	Alluminio / Aluminum	Rame Brillantato Spazzolato	Copper sparkling brushed		10
GSQA10031RSI	Alluminio / Aluminum	Rame Spazzolato Incrociato	Copper cross brushed		10
GSQA10031TBL	Alluminio / Aluminum	Titanio Brillantato Lucido	Titanium sparkling polished		10
GSQA10031TBS	Alluminio / Aluminum	Titanio Brillantato Spazzolato	Titanium sparkling brushed		10
GSQA10031TS	Alluminio / Aluminum	Titanio satinato	Titanium frosted		10
GSQA10031TSI	Alluminio / Aluminum	Titanio Spazzolato Incrociato	Titanium cross brushed		10
GSQA1003191	Alluminio / Aluminum	Bianco Ral 9010	White RAL 9010		10
GSQA10031GA	Alluminio / Aluminum	Grigio Antracite	Grey Anthracite		10
GSQA10031GAS	Alluminio / Aluminum	Grigio Antracite Scuro	Dark Gray Anthracite		10
GSQA10031NEO	Alluminio / Aluminum	Nero opaco	Matt Black		10
GSQA10031NBS	Alluminio / Aluminum	Nero Brillantato Spazzolato	Black sparkling brushed		10
GSQA10031OC	Alluminio / Aluminum	Oro Chiaro	Oro Chiaro/Gold		10
GSQA10031OBL	Alluminio / Aluminum	Oro Brillantato Lucido	Gold sparkling polished		10
GSQA10031OBS	Alluminio / Aluminum	Oro Brillantato Spazzolato	Brushed Bright Gold		10

NEW!

NEW!

NEW!

NEW!

NEW!

NEW!

NEW!

NEW!

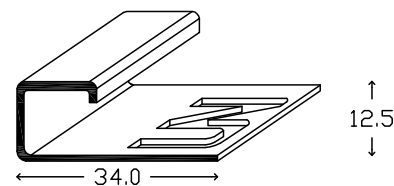

Esempio di posa
Installation example

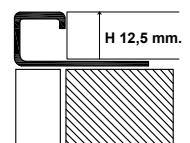

Lunghezza barre 2700mm / Bar length 2700mm

GSQA12534A	Alluminio / Aluminum	Argento	Silver		12,5
GSQA12534ABL	Alluminio / Aluminum	Argento Brillantato Lucido	Silver sparkling polished		12,5
GSQA12534ABS	Alluminio / Aluminum	Argento Brillantato Spazzolato	Silver sparkling brushed		12,5
GSQA12534RBL	Alluminio / Aluminum	Rame Brillantato Lucido	Copper sparkling polished		12,5
GSQA12534RBS	Alluminio / Aluminum	Rame Brillantato Spazzolato	Copper sparkling brushed		12,5
GSQA12534TBL	Alluminio / Aluminum	Titanio Brillantato Lucido	Titanium sparkling polished		12,5
GSQA12534TBS	Alluminio / Aluminum	Titanio Brillantato Spazzolato	Titanium sparkling brushed		12,5
GSQA1253491	Alluminio / Aluminum	Bianco Ral 9010	White RAL 9010		12,5
GSQA12534GA	Alluminio / Aluminum	Grigio Antracite	Grey Anthracite		12,5

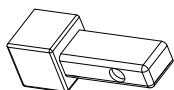

Capsule per raccordi interni, esterni e triassiali in alluminio
Capsules for internal, external and tri-axial connectors in aluminum

ART.	LEGA ALLOY	FINITURA	FINISH	H mm	pz/conf. pcs/pack
AEGSQA80A	Alluminio / Aluminum	Argento	Silver	8	4
AEGSQA80ABL	Alluminio / Aluminum	Argento Brillantato Lucido	Silver sparkling polished	8	4
AEGSQA80ABS	Alluminio / Aluminum	Argento Brillantato Spazzolato	Silver sparkling brushed	8	4
AEGSQA80RBL	Alluminio / Aluminum	Rame Brillantato Lucido	Copper sparkling polished	8	4
AEGSQA80RBS	Alluminio / Aluminum	Rame Brillantato Spazzolato	Copper sparkling brushed	8	4
AEGSQA80TBL	Alluminio / Aluminum	Titanio Brillantato Lucido	Titanium sparkling polished	8	4
AEGSQA80TBS	Alluminio / Aluminum	Titanio Brillantato Spazzolato	Titanium sparkling brushed	8	4
AEGSQA8091	Alluminio / Aluminum	Bianco Ral 9010	White RAL 9010	8	4
AEGSQA80NEO	Alluminio / Aluminum	Nero opaco	Matt Black	8	4
AEGSQA80NBS	Alluminio / Aluminum	Nero Brillantato Spazzolato	Black sparkling brushed	8	4
AEGSQA80GA	Alluminio / Aluminum	Grigio Antracite	Grey Anthracite	8	4
AEGSQA100A	Alluminio / Aluminum	Argento	Silver	10	4
AEGSQA100ABL	Alluminio / Aluminum	Argento Brillantato Lucido	Silver sparkling polished	10	4
AEGSQA100ABS	Alluminio / Aluminum	Argento Brillantato Spazzolato	Silver sparkling brushed	10	4
AEGSQA100B	Alluminio / Aluminum	Bronzo	Bronze	10	4
AEGSQA100BI	Alluminio / Aluminum	Bianco Ral 9003		10	4
AEGSQA100RBL	Alluminio / Aluminum	Rame Brillantato Lucido	Copper sparkling polished	10	4
AEGSQA100RBS	Alluminio / Aluminum	Rame Brillantato Spazzolato	Copper sparkling brushed	10	4
AEGSQA100TS	Alluminio / Aluminum	Titanio satinato	Titanium frosted	10	4
AEGSQA100TBL	Alluminio / Aluminum	Titanio Brillantato Lucido	Titanium sparkling polished	10	4
AEGSQA100TBS	Alluminio / Aluminum	Titanio Brillantato Spazzolato	Titanium sparkling brushed	10	4
AEGSQA10091	Alluminio / Aluminum	Bianco Ral 9010	White RAL 9010	10	4
AEGSQA100NEO	Alluminio / Aluminum	Nero opaco	Matt Black	10	4
AEGSQA100NBS	Alluminio / Aluminum	Nero Brillantato Spazzolato	Black sparkling brushed	10	4
AEGSQA100GA	Alluminio / Aluminum	Grigio Antracite	Grey Anthracite	10	4
AEGSQA100GAS	Alluminio / Aluminum	Grigio Antracite Scuro	Dark Grey Anthracite	10	4
AEGSQA100OBS	Alluminio / Aluminum	Oro Brillantato Spazzolato		10	4
AEGSQA100OC	Alluminio / Aluminum	Oro Chiaro	Gold	10	4
AEGSQA100OBL	Alluminio / Aluminum	Oro Brillantato Lucido	Gold sparkling polished	10	4
AEGSQA125A	Alluminio / Aluminum	Argento	Silver	12,5	4
AEGSQA125ABL	Alluminio / Aluminum	Argento Brillantato Lucido	Silver sparkling polished	12,5	4
AEGSQA125ABS	Alluminio / Aluminum	Argento Brillantato Spazzolato	Silver sparkling brushed	12,5	4
AEGSQA125RBL	Alluminio / Aluminum	Rame Brillantato Lucido	Copper sparkling polished	12,5	4
AEGSQA125RBS	Alluminio / Aluminum	Rame Brillantato Spazzolato	Copper sparkling brushed	12,5	4
AEGSQA125TBL	Alluminio / Aluminum	Titanio Brillantato Lucido	Titanium sparkling polished	12,5	4
AEGSQA125TBS	Alluminio / Aluminum	Titanio Brillantato Spazzolato	Titanium sparkling brushed	12,5	4
AEGSQA12591	Alluminio / Aluminum	Bianco Ral 9010	White RAL 9010	12,5	4

NEW!
NEW!
NEW!

NEW!

NEW!
NEW!

NEW!
NEW!
NEW!



UNYcer®-HQ-B

Nuovi profili UNYCERH-B linea PIETRA
New UNYCERH-B STONE line profiles

NEW!

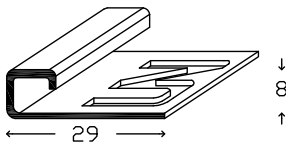

Esempio di posa
Installation example

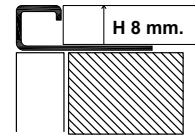

Lunghezza barre 2700mm / Bar length 2700mm

ART.	LEGA ALLOY	FINITURA	FINISH	COLORE COLOUR	H mm
GSQA8029PGRC	Alluminio / Aluminum	Pietra grigio chiaro	Light grey stone		8
GSQA8029PGR	Alluminio / Aluminum	Pietra grigio	Grey stone		8
GSQA8029PGRA	Alluminio / Aluminum	Pietra grigia antico	Ancient grey stone		8
GSQA8029GA	Alluminio / Aluminum	Pietra grigio antracite	Anthracite grey stone		8
GSQA8029GAS	Alluminio / Aluminum	Pietra grigio antracite scuro	Dark anthracite grey stone		8
GSQA8029PAG	Alluminio / Aluminum	Pietra avorio grigio	Grey ivory stone		8
GSQA8029PBC	Alluminio / Aluminum	Pietra beige chiaro	Light beige stone		8
GSQA8029PBA	Alluminio / Aluminum	Pietra beige antico	Antique beige stone		8
GSQA8029PBM	Alluminio / Aluminum	Pietra beige marrone	Brown beige stone		8
GSQA8029PCA	Alluminio / Aluminum	Pietra corten antico	Ancient corten stone		8

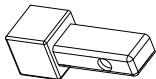

Capsule per raccordi interni, esterni e triassiali in alluminio
Capsules for internal, external and tri-axial connectors in aluminum

ART.	LEGA ALLOY	FINITURA	FINISH	H mm	pz/conf. pcs/pack
AEGSQA80PGRC	Alluminio / Aluminum	Pietra grigio chiaro	Light grey stone	8	4
AEGSQA80PGR	Alluminio / Aluminum	Pietra grigio	Grey stone	8	4
AEGSQA80PGRA	Alluminio / Aluminum	Pietra grigia antico	Ancient grey stone	8	4
AEGSQA80GA	Alluminio / Aluminum	Pietra grigio antracite	Anthracite grey stone	8	4
AEGSQA80GAS	Alluminio / Aluminum	Pietra grigio antracite scuro	Dark anthracite grey stone	8	4
AEGSQA80PAG	Alluminio / Aluminum	Pietra avorio grigio	Grey ivory stone	8	4
AEGSQA80PBC	Alluminio / Aluminum	Pietra beige chiaro	Light beige stone	8	4
AEGSQA80PBA	Alluminio / Aluminum	Pietra beige antico	Antique beige stone	8	4
AEGSQA80PBM	Alluminio / Aluminum	Pietra beige marrone	Brown beige stone	8	4
AEGSQA80PCA	Alluminio / Aluminum	Pietra corten antico	Ancient corten stone	8	4

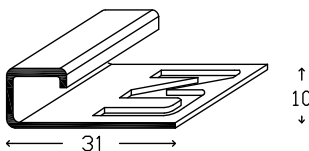

Esempio di posa
Installation example

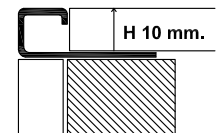

Lunghezza barre 2700mm / Bar length 2700mm

ART.	LEGA ALLOY	FINITURA	FINISH	COLORE COLOUR	H mm
GSQA10031PGRC	Alluminio / Aluminum	Pietra grigio chiaro	Light grey stone		10
GSQA10031PGR	Alluminio / Aluminum	Pietra grigio	Grey stone		10
GSQA10031PGRA	Alluminio / Aluminum	Pietra grigia antico	Ancient grey stone		10
GSQA10031GA	Alluminio / Aluminum	Pietra grigio antracite	Anthracite grey stone		10
GSQA10031GAS	Alluminio / Aluminum	Pietra grigio antracite scuro	Dark anthracite grey stone		10
GSQA10031PAG	Alluminio / Aluminum	Pietra avorio grigio	Grey ivory stone		10
GSQA10031PBC	Alluminio / Aluminum	Pietra beige chiaro	Light beige stone		10
GSQA10031PBA	Alluminio / Aluminum	Pietra beige antico	Antique beige stone		10
GSQA10031PBM	Alluminio / Aluminum	Pietra beige marrone	Brown beige stone		10
GSQA10031PCA	Alluminio / Aluminum	Pietra corten antico	Ancient corten stone		10

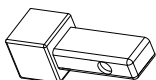

Capsule per raccordi interni, esterni e triassiali in alluminio
Capsules for internal, external and tri-axial connectors in aluminum

ART.	LEGA ALLOY	FINITURA	FINISH	H mm	pz/conf. pcs/pack
AEGSQA100PGRC	Alluminio / Aluminum	Pietra grigio chiaro	Light grey stone	10	4
AEGSQA100PGR	Alluminio / Aluminum	Pietra grigio	Grey stone	10	4
AEGSQA100PGRA	Alluminio / Aluminum	Pietra grigia antico	Ancient grey stone	10	4
AEGSQA100GA	Alluminio / Aluminum	Pietra grigio antracite	Anthracite grey stone	10	4
AEGSQA100GAS	Alluminio / Aluminum	Pietra grigio antracite scuro	Dark anthracite grey stone	10	4
AEGSQA100PAG	Alluminio / Aluminum	Pietra avorio grigio	Grey ivory stone	10	4
AEGSQA100PBC	Alluminio / Aluminum	Pietra beige chiaro	Light beige stone	10	4
AEGSQA100PBA	Alluminio / Aluminum	Pietra beige antico	Antique beige stone	10	4
AEGSQA100PBM	Alluminio / Aluminum	Pietra beige marrone	Brown beige stone	10	4
AEGSQA100PCA	Alluminio / Aluminum	Pietra corten antico	Ancient corten stone	10	4

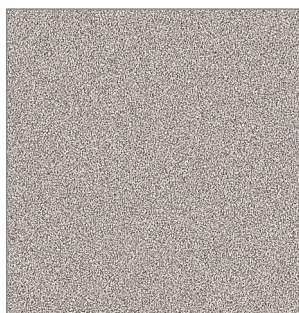

GRIGIO ANTICO
ANCIENT GRAY



GRIGIO
GRAY

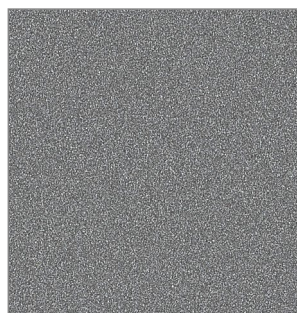

GRIGIO ANTRACITE
ANTHRACITE GRAY

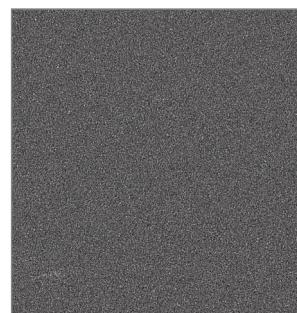

ANTRACITE SCURO
DARK ANTHRACITE GRAY



AVORIO GRIGIO
IVORY GRAY



BEIGE CHIARO
LIGHT BEIGE

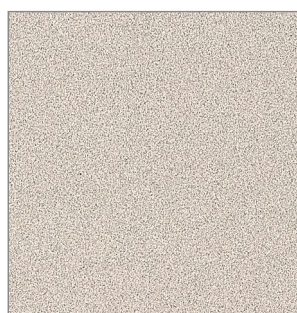

BEIGE ANTICO
ANCIENT BEIGE

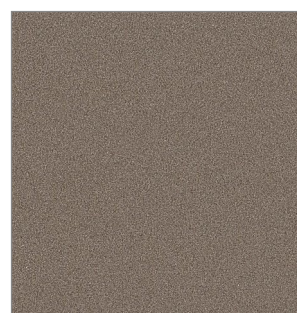

BEIGE MARRONE
BEIGE BROWN

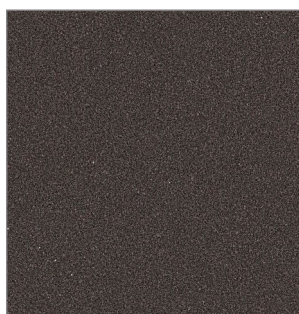

CORTEN ANTICO
ANCIENT CORTEN



GRIGIO CHIARO
LIGHT GREY



NERO OPACO
MATT BLACK

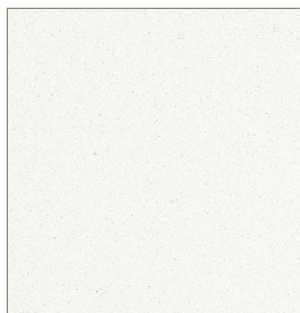

BIANCO OPACO
MATT WHITE



Art. UNYPANPIETRA
Espositore da banco
linea UNYCER ceramica
Counter display
UNYCER ceramic line



Le basi dei profili vengono fornite con apposita tranciatura e foratura per una più rapida ed efficace posa in opera dei profili sotto al rivestimento piastrellato.

The base of the profiles is supplied punched and drilled for a quicker and more efficient installation of the profiles under the tiled cladding.

Profili jolly in acciaio per la protezione degli angoli esterni delle piastrelle con base ad incastro. La caratteristica sagoma quadra permette molteplici realizzazioni e finiture di completamento.

Jolly profiles in steel for the protection of external corners of tiles with interlocking bases. The characteristic square shape allows for numerous creations and finishing

UNYcer®-HQ-B Profilo con base ad incastro
Profile with interlocking base

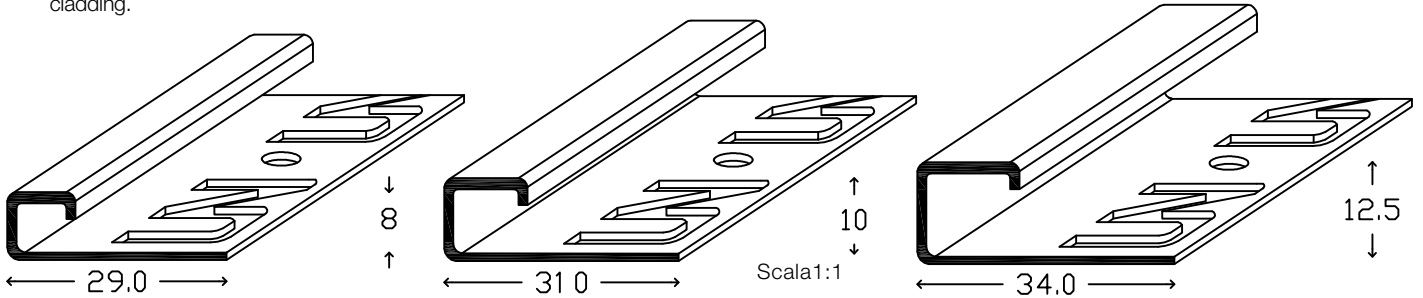

ARTICOLO	MATERIALE MATERIAL	FINITURA FINISH	COLORE COLOUR	Lung. mm. Leng. mm.	H. mm
GSQI8029L/304	Acciaio Inox* / Stainless steel*	Lucido con protettivo / Polished with protective		2700	8
GSQI8029S/304	Acciaio Inox* / Stainless steel*	Spazzolato con protettivo / Brushed with protective		2700	8
GSQI10031L/304	Acciaio Inox* / Stainless steel*	Lucido con protettivo / Polished with protective		2700	10
GSQI10031S/304	Acciaio Inox* / Stainless steel*	Spazzolato con protettivo / Brushed with protective		2700	10
GSQI11031L/304	Acciaio Inox* / Stainless steel*	Lucido con protettivo / Polished with protective		2700	11
GSQI11031S/304	Acciaio Inox* / Stainless steel*	Spazzolato con protettivo / Brushed with protective		2700	11
GSQI12534L/304	Acciaio Inox* / Stainless steel*	Lucido con protettivo / Polished with protective		2700	12,5
GSQI12534S/304	Acciaio Inox* / Stainless steel*	Spazzolato con protettivo / Brushed with protective		2700	12,5

*Acciaio Inox AISI 304 DIN 1.4301 / Stainless steel AISI 304 DIN 1.4301

Esempio di posa
Installation example

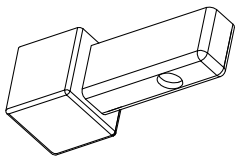
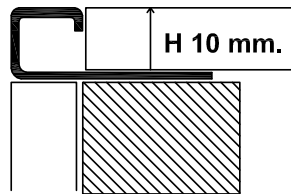

Capsule per raccordi interni, esterni e triassiali in acciaio inox AISI 304
Capsules for connectors; internal, external and tri-axle in stainless steel AISI 304

ARTICOLO	LEGA	ALLOY	FINITURA FINISH	H. mm	pz/conf. pcs/pack
AEVAGSQI80L304S	Acciaio inox aisi 304	Stainless steel aisi 304	Lucido	8	1
AEVAGSQI80S304S	Acciaio inox aisi 304	Stainless steel aisi 304	Spazzolato	8	1
AEVAGSQI10L304S	Acciaio inox aisi 304	Stainless steel aisi 304	Lucido	10	1
AEVAGSQI10S304S	Acciaio inox aisi 304	Stainless steel aisi 304	Spazzolato	10	1
AEVAGSQI11L304S	Acciaio inox aisi 304	Stainless steel aisi 304	Lucido	11	1
AEVAGSQI11S304S	Acciaio inox aisi 304	Stainless steel aisi 304	Spazzolato	11	1
AEVAGSQI12L304S	Acciaio inox aisi 304	Stainless steel aisi 304	Lucido	12,5	1
AEVAGSQI12S304S	Acciaio inox aisi 304	Stainless steel aisi 304	Spazzolato	12,5	1
AEVAGSQI80L/304	Acciaio inox aisi 304	Stainless steel aisi 304	Lucido	8	4
AEVAGSQI80S/304	Acciaio inox aisi 304	Stainless steel aisi 304	Spazzolato	8	4
AEVAGSQI100L/304	Acciaio inox aisi 304	Stainless steel aisi 304	Lucido	10	4
AEVAGSQI100S/304	Acciaio inox aisi 304	Stainless steel aisi 304	Spazzolato	10	4
AEVAGSQI110L/304	Acciaio inox aisi 304	Stainless steel aisi 304	Lucido	11	4
AEVAGSQI110S/304	Acciaio inox aisi 304	Stainless steel aisi 304	Spazzolato	11	4
AEVAGSQI125L304	Acciaio inox aisi 304	Stainless steel aisi 304	Lucido	12,5	4
AEVAGSQI125S304	Acciaio inox aisi 304	Stainless steel aisi 304	Spazzolato	12,5	4

Profili per la protezione degli spigoli delle piastrelle con base ad incastro.
PVC antiurto senza piombo.

Profiles for protecting edges of tiles with interlocking base.
Anti-shock PVC without lead.

Le basi dei profili vengono fornite con apposita tranciatura e foratura per una più rapida ed efficace posa in opera dei profili sotto al rivestimento piastrellato.

The base of the profiles is supplied punched and drilled for a quicker and more efficient installation of the profiles under the tiled cladding.

UNYcer®-J-B

Profilo jolly in PVC - Jolly profile in PVC

ART.	MATERIALE MATERIAL	FINITURA FINISH	COLORE COLOUR	Lung. mm. Leng. mm.	H. mm
JQP8032BI	Pvc	Bianco Ral 9003/ White Ral9003		2700	8
JQP8032BE	Pvc	Beige		2700	8
JQP8032GR	Pvc	Grigio Ral 7040/ Grey Ral 7040		2700	8
JQP8032NE	Pvc	Nero Ral 9004/ Black Ral 9004		2700	8

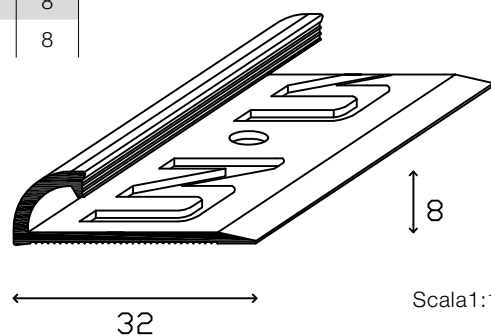

UNYcer®-J-B

Profilo jolly in PVC - Jolly profile in PVC

ART.	MATERIALE MATERIAL	FINITURA FINISH	COLORE COLOUR	Lung. mm. Leng. mm.	H. mm
JQP10032BI	Pvc	Bianco Ral 9003/ White Ral9003		2700	10
JQP10032BE	Pvc	Beige		2700	10
JQP10032GR	Pvc	Grigio Ral 7040/ Grey Ral 7040		2700	10
JQP10032NE	Pvc	Nero Ral 9004/ Black Ral 9004		2700	10

Esempio di posa
 Installation example

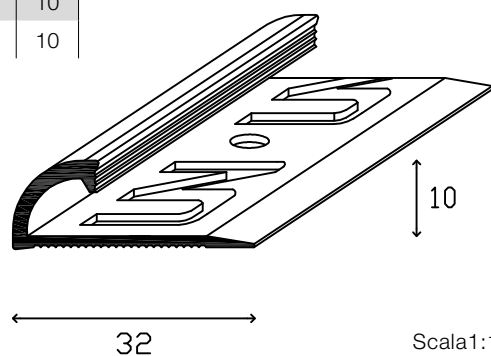
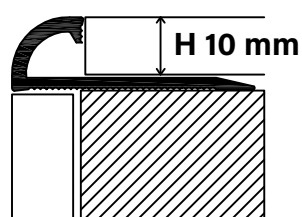

Capsule esterne di chiusura in PVC - External closure capsules in PVC

ART.	MATERIALE MATERIAL	FINITURA FINISH	COLORE COLOUR	H. mm	Pezzi x conf. Pcs /pack
AEJQP80BI	Pvc	Bianco Ral 9003/ White Ral9003		8	4
AEJQP80BE	Pvc	Beige		8	4
AEJQP80GR	Pvc	Grigio Ral 7040/ Grey Ral 7040		8	4
AEJQP80NE	Pvc	Nero Ral 9004/ Black Ral 9004		8	4
AEJQP100BI	Pvc	Bianco Ral 9003/ White Ral9003		10	4
AEJQP100BE	Pvc	Beige		10	4
AEJQP100GR	Pvc	Grigio Ral 7040/ Grey Ral 7040		10	4
AEJQP100NE	Pvc	Nero Ral 9004/ Black Ral 9004		10	4

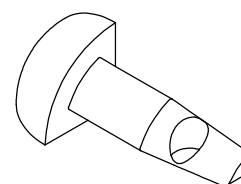

Le basi dei profili vengono fornite con apposita tranciatura e foratura per una più rapida ed efficace posa in opera dei profili sotto al rivestimento piastrellato.

The base of the profiles is supplied punched and drilled for a quicker and more efficient installation of the profiles under the tiled cladding.

Jolly per spessori sottili
Jolly for thin thicknesses

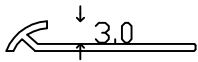

Jolly per spessori sottili
Jolly for thin thicknesses

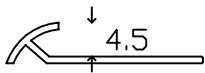

Esempio di posa
Installation example

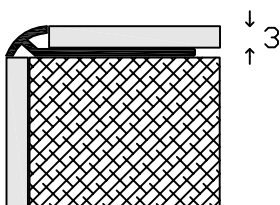

Profili jolly per la protezione degli spigoli delle piastrelle con base ad incastro.

Jolly profiles for protecting edges of tiles with interlocking base.

UNYcer®-J-B Profilo jolly per bassi spessori in alluminio
Jolly profile for low thicknesses in aluminum

Lunghezza barre 2700mm / Bar length 2700mm

ART.	LEGA ALLOY	FINITURA FINISH	COLORE COLOUR	H mm
JQA3025A	Alluminio / Aluminum	Argento/ Silver		3
JQA3025ABL	Alluminio / Aluminum	Argento Brillantato Lucido Silver sparkling polished		3
JQA3025ABS	Alluminio / Aluminum	Argento Brillantato Spazzolato Silver sparkling brushed		3
JQA3025RBL	Alluminio / Aluminum	Rame Brillantato Lucido Copper sparkling polished		3
JQA3025RBS	Alluminio / Aluminum	Rame Brillantato Spazzolato Copper sparkling brushed		3
JQA3025TBL	Alluminio / Aluminum	Titanio Brillantato Lucido Titanium sparkling polished		3
JQA3025TBS	Alluminio / Aluminum	Titanio Brillantato Spazzolato Titanium sparkling brushed		3
JQA302591	Alluminio / Aluminum	Bianco Ral 9010 White Ral 9010		3
JQA4526A	Alluminio / Aluminum	Argento/ Silver		4,5
JQA4526ABL	Alluminio / Aluminum	Argento Brillantato Lucido Silver sparkling polished		4,5
JQA4526ABS	Alluminio / Aluminum	Argento Brillantato Spazzolato Silver sparkling brushed		4,5
JQA4526RBL	Alluminio / Aluminum	Rame Brillantato Lucido Copper sparkling polished		4,5
JQA4526RBS	Alluminio / Aluminum	Rame Brillantato Spazzolato Copper sparkling brushed		4,5
JQA4526TBL	Alluminio / Aluminum	Titanio Brillantato Lucido Titanium sparkling polished		4,5
JQA4526TBS	Alluminio / Aluminum	Titanio Brillantato Spazzolato Titanium sparkling brushed		4,5
JQA452691	Alluminio / Aluminum	Bianco Ral 9010 White Ral 9010		4,5



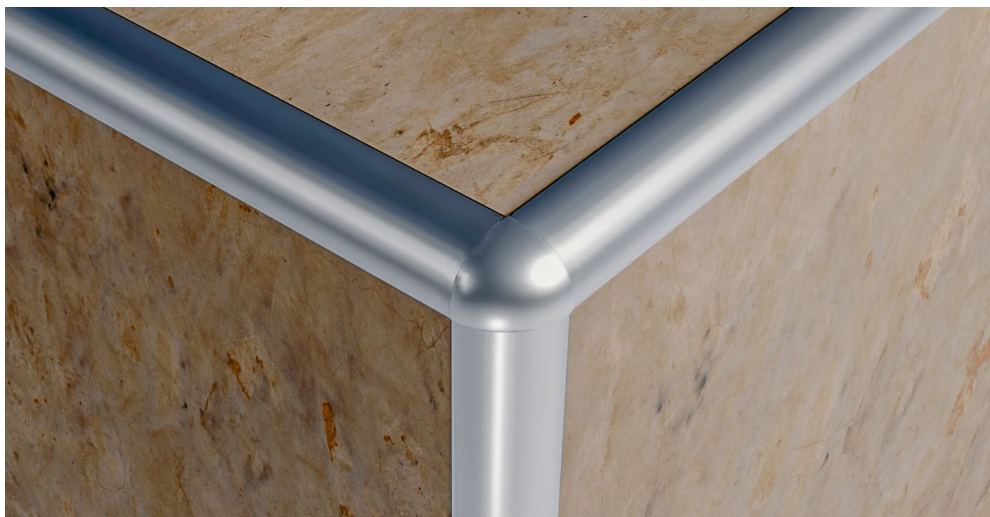

Profili jolly per la protezione degli spigoli delle piastrelle con base ad incastro.

Jolly profiles for protecting the edges of tiles with interlocking base

Le basi dei profili vengono fornite con apposita tranciatura e foratura per una più rapida ed efficace posa in opera dei profili sotto al rivestimento piastrellato.

The base of the profiles is supplied punched and drilled for a quicker and more efficient installation of the profiles under the tiled cladding.

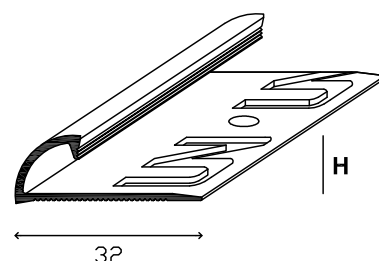

UNYcer®-J-B Profilo jolly in alluminio - Jolly profile in aluminum

Lunghezza barre 2700mm / Bar length 2700mm

ART.	LEGA ALLOY	FINITURA FINISH	COLORE COLOUR	H mm
JQA6032A	Alluminio / Aluminum	Argento/ Silver		6
JQA6032ABL	Alluminio / Aluminum	Argento Brillantato Lucido Silver sparkling polished		6
JQA6032ABS	Alluminio / Aluminum	Argento Brillantato Spazzolato Silver sparkling brushed		6
JQA6032TBL	Alluminio / Aluminum	Titanio Brillantato Lucido Titanium sparkling polished		6
JQA6032TBS	Alluminio / Aluminum	Titanio Brillantato Spazzolato Titanium sparkling brushed		6
JQA603291	Alluminio / Aluminum	Bianco Ral 9010 White Ral 9010		6

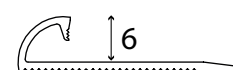

Lunghezza barre 2700mm / Bar length 2700mm

JQA8032A	Alluminio / Aluminum	Argento/ Silver		8
JQA8032ABL	Alluminio / Aluminum	Argento Brillantato Lucido Silver sparkling polished		8
JQA8032ABS	Alluminio / Aluminum	Argento Brillantato Spazzolato Silver sparkling brushed		8
JQA8032NEO	Alluminio / Aluminum	Nero opaco anodizzato Anodized matt black		8
JQA8032RBL	Alluminio / Aluminum	Rame Brillantato Lucido Copper sparkling polished		8
JQA8032RBS	Alluminio / Aluminum	Rame Brillantato Spazzolato Copper sparkling brushed		8
JQA10032TS	Alluminio / Aluminum	Titanio Satinato Satin Titanium		8
JQA8032TBL	Alluminio / Aluminum	Titanio Brillantato Lucido Titanium sparkling polished		8
JQA8032TBS	Alluminio / Aluminum	Titanio Brillantato Spazzolato Titanium sparkling brushed		8
JQA803291	Alluminio / Aluminum	Bianco Ral 9010 White Ral 9010		8

NEW!

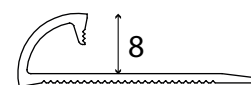

NEW!

Lunghezza barre 2700mm / Bar length 2700mm

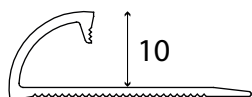

JQA10032A	Alluminio / Aluminum	Argento/ Silver		10
JQA10032ABL	Alluminio / Aluminum	Argento Brillantato Lucido Silver sparkling polished		10
JQA10032ABS	Alluminio / Aluminum	Argento Brillantato Spazzolato Silver sparkling brushed		10
JQA10032NEO	Alluminio / Aluminum	Nero opaco anodizzato Anodized matt black		10
JQA10032RBL	Alluminio / Aluminum	Rame Brillantato Lucido Copper sparkling polished		10
JQA10032RBS	Alluminio / Aluminum	Rame Brillantato Spazzolato Copper sparkling brushed		10
JQA10032TS	Alluminio / Aluminum	Titanio Satinato Satin Titanium		10
JQA10032TBL	Alluminio / Aluminum	Titanio Brillantato Lucido Titanium sparkling polished		10
JQA10032TBS	Alluminio / Aluminum	Titanio Brillantato Spazzolato Titanium sparkling brushed		10
JQA1003291	Alluminio / Aluminum	Bianco Ral 9010 White Ral 9010		10

Lunghezza barre 2700mm / Bar length 2700mm

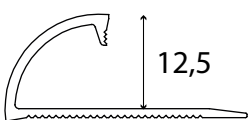



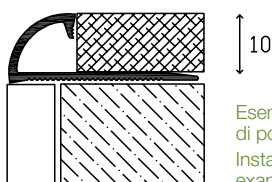



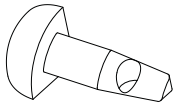



JQA12532A	Alluminio / Aluminum	Argento/ Silver		12,5
JQA12532ABL	Alluminio / Aluminum	Argento Brillantato Lucido Silver sparkling polished		12,5
JQA12532ABS	Alluminio / Aluminum	Argento Brillantato Spazzolato Silver sparkling brushed		12,5
JQA12532RBL	Alluminio / Aluminum	Rame Brillantato Lucido Copper sparkling polished		12,5
JQA12532RBS	Alluminio / Aluminum	Rame Brillantato Spazzolato Copper sparkling brushed		12,5
JQA1253291	Alluminio / Aluminum	Bianco Ral 9010 White Ral 9010		12,5













Esempio di posa
Installation example

UNYcer-J-B Capsule triassiali esterne di chiusura in alluminio
 Tri-axial external closure capsules in aluminum

ART.	LEGA ALLOY	FINITURA FINISH	COLORE COLOUR	H mm	pz/conf. pcs/pack
AEJQA60A	Alluminio / Aluminum	Argento/ Silver		6	4
AEJQA60ABL	Alluminio / Aluminum	Argento Brillantato Lucido Silver sparkling polished		6	4
AEJQA60ABS	Alluminio / Aluminum	Argento Brillantato Spazzolato Silver sparkling brushed		6	4
AEJQA6091	Alluminio / Aluminum	Bianco Ral 9010 White Ral 9010		6	4

ART.	LEGA ALLOY	FINITURA FINISH	COLORE COLOUR	H mm	pz/conf. pcs/pack
AEJQA80A	Alluminio / Aluminum	Argento/ Silver		8	4
AEJQA80ABL	Alluminio / Aluminum	Argento Brillantato Lucido Silver sparkling polished		8	4
AEJQA80ABS	Alluminio / Aluminum	Argento Brillantato Spazzolato Silver sparkling brushed		8	4
AEJQA80NEO	Alluminio / Aluminum	Nero opaco anodizzato Anodized matt black		8	4
AEJQA80RBL	Alluminio / Aluminum	Rame Brillantato Lucido Copper sparkling polished		8	4
AEJQA80RBS	Alluminio / Aluminum	Rame Brillantato Spazzolato Copper sparkling brushed		8	4
AEJQA80TS	Alluminio / Aluminum	Titanio Satinato Satin Titanium		8	4
AEJQA80TBL	Alluminio / Aluminum	Titanio Brillantato Lucido Titanium sparkling polished		8	4
AEJQA80TBS	Alluminio / Aluminum	Titanio Brillantato Spazzolato Titanium sparkling brushed		8	4
AEJQA8091	Alluminio / Aluminum	Bianco Ral 9010 White Ral 9010		8	4

NEW!
NEW!

ART.	LEGA ALLOY	FINITURA FINISH	COLORE COLOUR	H mm	pz/conf. pcs/pack
AEJQA100A	Alluminio / Aluminum	Argento/ Silver		10	4
AEJQA100ABL	Alluminio / Aluminum	Argento Brillantato Lucido Silver sparkling polished		10	4
AEJQA100ABS	Alluminio / Aluminum	Argento Brillantato Spazzolato Silver sparkling brushed		10	4
AEJQA100NEO	Alluminio / Aluminum	Nero opaco anodizzato Anodized matt black		10	4
AEJQA100RBL	Alluminio / Aluminum	Rame Brillantato Lucido Copper sparkling polished		10	4
AEJQA100RBS	Alluminio / Aluminum	Rame Brillantato Spazzolato Copper sparkling brushed		10	4
AEJQA100TS	Alluminio / Aluminum	Titanio Satinato Satin Titanium		10	4
AEJQA100TBL	Alluminio / Aluminum	Titanio Brillantato Lucido Titanium sparkling polished		10	4
AEJQA100TBS	Alluminio / Aluminum	Titanio Brillantato Spazzolato Titanium sparkling brushed		10	4
AEJQA10091	Alluminio / Aluminum	Bianco Ral 9010 White Ral 9010		10	4

NEW!
NEW!

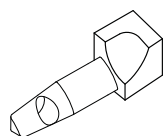

Capsule triassiali interne di chiusura in alluminio
Tri-axial internal closure capsules in aluminum

ART.	LEGA ALLOY	FINITURA FINISH	COLORE COLOUR	H mm	pz/conf. pcs/pack
AIJQA60A	Alluminio / Aluminum	Argento/ Silver		6	4
AIJQA60ABL	Alluminio / Aluminum	Argento Brillantato Lucido Silver sparkling polished		6	4
AIJQA60ABS	Alluminio / Aluminum	Argento Brillantato Spazzolato Silver sparkling brushed		6	4
AIJQA6091	Alluminio / Aluminum	Bianco Ral 9010 / White Ral 9010		6	4

ART.	LEGA ALLOY	FINITURA FINISH	COLORE COLOUR	H mm	pz/conf. pcs/pack
AIJQA80A	Alluminio / Aluminum	Argento/ Silver		8	4
AIJQA80ABL	Alluminio / Aluminum	Argento Brillantato Lucido Silver sparkling polished		8	4
AIJQA80ABS	Alluminio / Aluminum	Argento Brillantato Spazzolato Silver sparkling brushed		8	4
AIJQA80NEO	Alluminio / Aluminum	Nero opaco anodizzato Anodized matt black		8	4
AIJQA80RBL	Alluminio / Aluminum	Rame Brillantato Lucido Copper sparkling polished		8	4
AIJQA80RBS	Alluminio / Aluminum	Rame Brillantato Spazzolato Copper sparkling brushed		8	4
AIJQA80TS	Alluminio / Aluminum	Titanio Satinato Satin Titanium		8	4
AIJQA80TBL	Alluminio / Aluminum	Titanio Brillantato Lucido Titanium sparkling polished		8	4
AIJQA80TBS	Alluminio / Aluminum	Titanio Brillantato Spazzolato Titanium sparkling brushed		8	4
AIJQA8091	Alluminio / Aluminum	Bianco Ral 9010 / White Ral 9010		8	4

NEW!

NEW!

ART.	LEGA ALLOY	FINITURA FINISH	COLORE COLOUR	H mm	pz/conf. pcs/pack
AIJQA100A	Alluminio / Aluminum	Argento/ Silver		10	4
AIJQA100ABL	Alluminio / Aluminum	Argento Brillantato Lucido Silver sparkling polished		10	4
AIJQA100ABS	Alluminio / Aluminum	Argento Brillantato Spazzolato Silver sparkling brushed		10	4
AIJQA100NEO	Alluminio / Aluminum	Nero opaco anodizzato Anodized matt black		10	4
AIJQA100RBL	Alluminio / Aluminum	Rame Brillantato Lucido Copper sparkling polished		10	4
AIJQA100RBS	Alluminio / Aluminum	Rame Brillantato Spazzolato Copper sparkling brushed		10	4
AIJQA100TBL	Alluminio / Aluminum	Titanio Satinato Satin Titanium		10	4
AIJQA100TBS	Alluminio / Aluminum	Titanio Brillantato Lucido Titanium sparkling polished		10	4
AIJQA100TS	Alluminio / Aluminum	Titanio Brillantato Spazzolato Titanium sparkling brushed		10	4
AIJQA10091	Alluminio / Aluminum	Bianco Ral 9010 / White Ral 9010		10	4

NEW!

NEW!

ART.	LEGA ALLOY	FINITURA FINISH	COLORE COLOUR	H mm	pz/conf. pcs/pack
AIJQA125A	Alluminio / Aluminum	Argento/ Silver		12,5	4
AIJQA125ABL	Alluminio / Aluminum	Argento Brillantato Lucido Silver sparkling polished		12,5	4
AIJQA125ABS	Alluminio / Aluminum	Argento Brillantato Spazzolato Silver sparkling brushed		12,5	4
AIJQA125RBL	Alluminio / Aluminum	Rame Brillantato Lucido Copper sparkling polished		12,5	4
AIJQA125RBS	Alluminio / Aluminum	Rame Brillantato Spazzolato Copper sparkling brushed		12,5	4
AIJQA12591	Alluminio / Aluminum	Bianco Ral 9010 / White Ral 9010		12,5	4

Profili per la protezione degli spigoli delle piastrelle con base ad incastro. Acciaio Inox.

Profiles for protecting the edges of tiles with interlocking base. Stainless steel.

Le basi dei profili vengono fornite con apposita tranciatura e foratura per una più rapida ed efficace posa in opera dei profili sotto al rivestimento piastrellato.

The base of the profiles is supplied punched and drilled for a quicker and more efficient installation of the profiles under the tiled cladding.

UNYcer®-J-B Profilo jolly in acciaio Inox / Jolly profile in stainless steel

ARTICOLO	MATERIALE MATERIAL	FINITURA FINISH	COLORE COLOUR	Lung. mm. Leng. mm.	H. mm
JQI4525L/304	Acciaio Inox*/ Stainless steel*	Lucido con protettivo / Polished with protective		2700	4,5
JQI4525S/304	Acciaio Inox*/ Stainless steel*	Spazzolato con protettivo / Brushed with protective		2700	4,5
JQI6025L/304	Acciaio Inox*/ Stainless steel*	Lucido con protettivo / Polished with protective		2700	6
JQI6025S/304	Acciaio Inox*/ Stainless steel*	Spazzolato con protettivo / Brushed with protective		2700	6
JQI8032L/304	Acciaio Inox*/ Stainless steel*	Lucido con protettivo / Polished with protective		2700	8
JQI8032S/304	Acciaio Inox*/ Stainless steel*	Spazzolato con protettivo / Brushed with protective		2700	8
JQI10032L/304	Acciaio Inox*/ Stainless steel*	Lucido con protettivo / Polished with protective		2700	10
JQI10032S/304	Acciaio Inox*/ Stainless steel*	Spazzolato con protettivo / Brushed with protective		2700	10
JQI12532L/304	Acciaio Inox*/ Stainless steel*	Lucido con protettivo / Polished with protective		2700	12,5
JQI12532S/304	Acciaio Inox*/ Stainless steel*	Spazzolato con protettivo / Brushed with protective		2700	12,5

*Acciaio Inox AISI 304 DIN 1.4301 / Stainless steel AISI 304 DIN 1.4301

Esempio di posa
Installation example

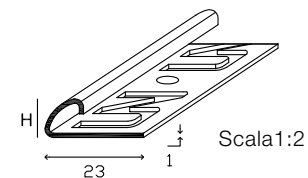
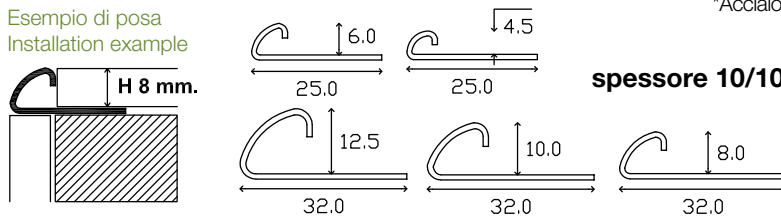

Capsule interne esterne triassiali per jolli tondi vero acciaio inox aisi 304

Tri-axial internal and external closure capsules in stainless steel aisi 304 for round profiles jolly

ART.	LEGA	ALLOY	FINITURA FINISH	H. mm	pz/conf. pcs/pack
AEVAJQI60L304S	Acciaio inox aisi 304	Stainless steel aisi 304	Lucido / Polished	6	1
AEVAJQI60S304S	Acciaio inox aisi 304	Stainless steel aisi 304	Spazzolato/Brushed	6	1
AEVAJQI80L304S	Acciaio inox aisi 304	Stainless steel aisi 304	Lucido / Polished	8	1
AEVAJQI80S304S	Acciaio inox aisi 304	Stainless steel aisi 304	Spazzolato / Brushed	8	1
AEVAJQI10L304S	Acciaio inox aisi 304	Stainless steel aisi 304	Lucido / Polished	10	1
AEVAJQI10S304S	Acciaio inox aisi 304	Stainless steel aisi 304	Spazzolato / Brushed	10	1
AEVAJQI12L304S	Acciaio inox aisi 304	Stainless steel aisi 304	Lucido / Polished	12,5	1
AEVAJQI12S304S	Acciaio inox aisi 304	Stainless steel aisi 304	Spazzolato / Brushed	12,5	1

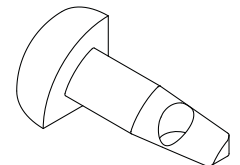

ART.	LEGA	ALLOY	FINITURA FINISH	H. mm	pz/conf. pcs/pack
AIVAJQI60L304S	Acciaio inox aisi 304	Stainless steel aisi 304	Lucido/ Brushed	6	1
AIVAJQI60S304S	Acciaio inox aisi 304	Stainless steel aisi 304	Spazzolato/Brushed	6	1
AIVAJQI80L304S	Acciaio inox aisi 304	Stainless steel aisi 304	Lucido / Brushed	8	1
AIVAJQI80S304S	Acciaio inox aisi 304	Stainless steel aisi 304	Spazzolato / Brushed	8	1
AIVAJQI10L304S	Acciaio inox aisi 304	Stainless steel aisi 304	Lucido / Polished	10	1
AIVAJQI10S304S	Acciaio inox aisi 304	Stainless steel aisi 304	Spazzolato / Brushed	10	1
AIVAJQI12L304S	Acciaio inox aisi 304	Stainless steel aisi 304	Lucido / Polished	12,5	1
AIVAJQI12S304S	Acciaio inox aisi 304	Stainless steel aisi 304	Spazzolato / Brushed	12,5	1

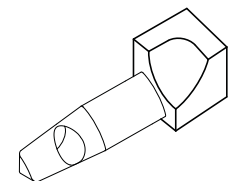

Capsule interne esterne triassiali per jolli tondi vero acciaio inox aisi 304

Tri-axial internal and external closure capsules in stainless steel aisi 304 for round profiles jolly

ART.	LEGA ALLOY	FINITURA	FINISH	H. mm	pz/conf. pcs/pack
AIVAJQI60L/304	Acciaio Inox Aisi 304	Lucido	Sparkling	6	4
AIVAJQI60S/304	Acciaio Inox Aisi 304	Spazzolato	Brushed	6	4
AEVAJQI60L/304	Acciaio Inox Aisi 304	Lucido	Sparkling	6	4
AEVAJQI60S/304	Acciaio Inox Aisi 304	Spazzolato	Brushed	6	4
AIVAJQI80L/304	Acciaio Inox Aisi 304	Lucido	Sparkling	8	4
AIVAJQI80S/304	Acciaio Inox Aisi 304	Spazzolato	Brushed	8	4
AEVAJQI80L/304	Acciaio Inox Aisi 304	Lucido	Sparkling	8	4
AEVAJQI80S/304	Acciaio Inox Aisi 304	Spazzolato	Brushed	8	4
AIVAJQI100L/304	Acciaio Inox Aisi 304	Lucido	Sparkling	10	4
AIVAJQI100S/304	Acciaio Inox Aisi 304	Spazzolato	Brushed	10	4
AEVAJQI100L/304	Acciaio Inox Aisi 304	Lucido	Sparkling	10	4
AEVAJQI100S/304	Acciaio Inox Aisi 304	Spazzolato	Brushed	10	4
AIVAJQI125L/304	Acciaio Inox Aisi 304	Lucido	Sparkling	12,50	4
AIVAJQI125S/304	Acciaio Inox Aisi 304	Spazzolato	Brushed	12,50	4
AEVAJQI125L/304	Acciaio Inox Aisi 304	Lucido	Sparkling	12,50	4
AEVAJQI125S/304	Acciaio Inox Aisi 304	Spazzolato	Brushed	12,50	4

Le basi dei profili vengono fornite con apposita tranciatura e foratura per una più rapida ed efficace posa in opera dei profili sotto al rivestimento piastrellato.

The base of the profiles is supplied punched and drilled for a quicker and more efficient installation of the profiles under the tiled cladding.

Profili per la protezione degli angoli interni delle piastrelle con base ad incastro in pvc e alluminio. Facilita la pulizia impedendo alla polvere e all'umidità di infiltrarsi negli angoli; può essere usato anche per raccordare i rivestimenti con la vasca da bagno, il piatto doccia e i sanitari, o come giunto di dilatazione perimetrale.

Profiles for the protection of internal corners of tiles with interlocking bases in PVC and aluminum. Facilitates cleaning by stopping dust and humidity from entering into the corners; it can also be used to join cladding with the bath tub, shower tray and sanitaryware or as a perimeter expansion joint.

UNYcer-JI-B Profilo jolly - Jolly profile

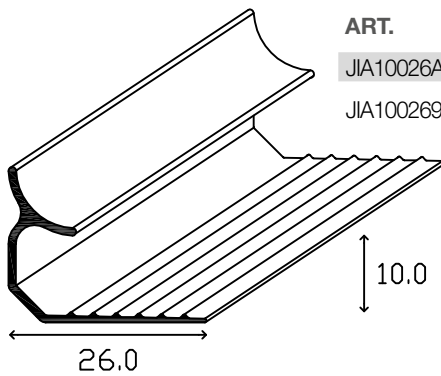

Esempio di posa
Installation example

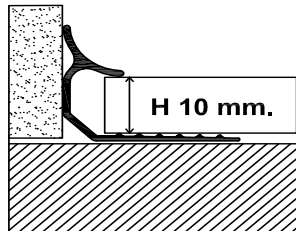

ART.	LEGA ALLOY	FINITURA FINISH	Lung. mm. Leng. mm.	H mm
JIA10026A	Alluminio / Aluminum	Argento / Silver	2700	10
JIA1002691	Alluminio / Aluminum	Bianco (Ral 9010) White Ral9010	2700	10

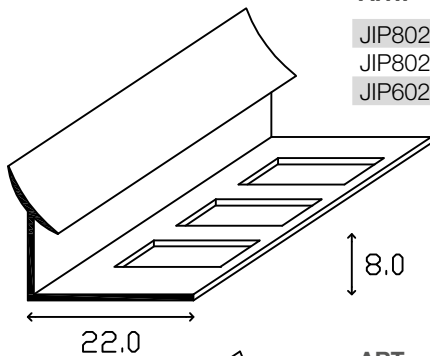

ART.	LEGA ALLOY	FINITURA FINISH	Lung. mm. Leng. mm.	H mm
JIP8022BI	Pvc	Bianco Ral 9003 / White Ral9003	2700	8
JIP8022NE	Pvc	Nero Ral 9004 / Black Ral 9004	2700	8
JIP6022BI	Pvc	Bianco Ral 9003 / White Ral9003	2700	6

NEW!

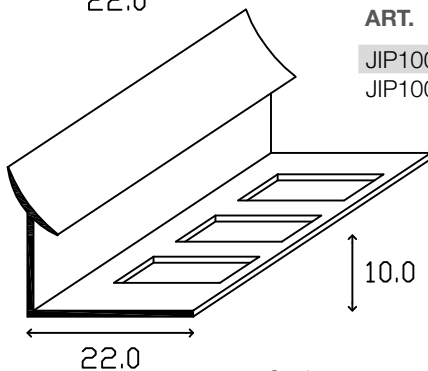

ART.	LEGA ALLOY	FINITURA FINISH	Lung. mm. Leng. mm.	H mm
JIP10022BI	Pvc	Bianco Ral 9003 / White Ral9003	2700	10
JIP10022NE	Pvc	Nero Ral 9004 / Black Ral 9004	2700	10

Scala 1:1

Esempio di posa
Installation example

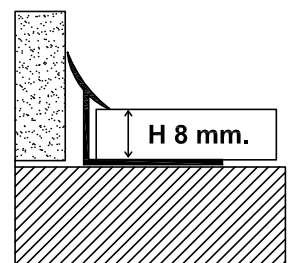

Giunti elastici di frazionamento per piastrelle per posa a colla Elastic separation joints for tiles laid using adhesive

Resistenti ai principali agenti chimici sono utilizzabili anche all'esterno

Resistant to most chemical agents, they can be used outside

UNYcer-GE Giunti elastici - Elastic Joints

ART.	MAT.	FINITURA FINISH	COLORE COLOUR	Lung. mm. Leng. mm	Misura. mm Measure, mm.
GPPVC78GT	PVC	Grigio + interno trasparente Grey + transparent interior		2000	7x8
GPPVC78GG	PVC	Grigio + interno grigio Gray + gray interior		2000	7x8
GPPVC78MT	PVC	Marrone + interno trasparente Brown + transparent interior		2000	7x8

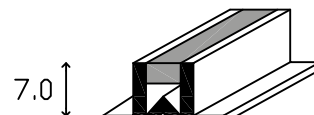

ART.	MAT.	FINITURA FINISH	COLORE COLOUR	Lung. mm. Leng. mm	Misura. mm Measure, mm.
GPPVC98GT	PVC	Grigio + interno trasparente Grey + transparent interior		2000	9x8
GPPVC98GG	PVC	Grigio + interno grigio Gray + gray interior		2000	9x8
GPPVC98MT	PVC	Marrone + interno trasparente Brown + transparent interior		2000	9x8

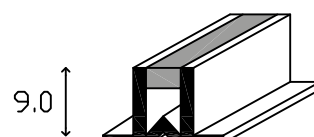

ART.	MAT.	FINITURA FINISH	COLORE COLOUR	Lung. mm. Leng. mm	Misura. mm Measure, mm.
GPPVC118GT	PVC	Grigio + interno trasparente Grey + transparent interior		2000	11x8
GPPVC118GG	PVC	Grigio + interno grigio Gray + gray interior		2000	11x8
GPPVC118MT	PVC	Marrone + interno trasparente Brown + transparent interior		2000	11x8

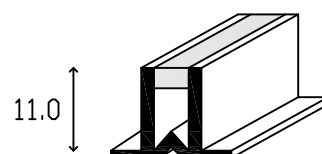

ART.	MAT.	FINITURA FINISH	COLORE COLOUR	Lung. mm. Leng. mm	Misura. mm Measure, mm.
GPPVC138GT	PVC	Grigio + interno trasparente Grey + transparent interior		2000	13x8
GPPVC138GG	PVC	Grigio + interno grigio Gray + gray interior		2000	13x8
GPPVC138MT	PVC	Marrone + interno trasparente Brown + transparent interior		2000	13x8

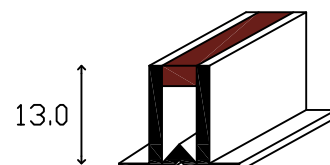

ART.	MAT.	FINITURA FINISH	COLORE COLOUR	Lung. mm. Leng. mm	Misura. mm Measure, mm.
GPPVC158GT	PVC	Grigio + interno trasparente Grey + transparent interior		2000	15x8
GPPVC158GG	PVC	Grigio + interno grigio Gray + gray interior		2000	15x8
GPPVC158MT	PVC	Marrone + interno trasparente Brown + transparent interior		2000	15x8

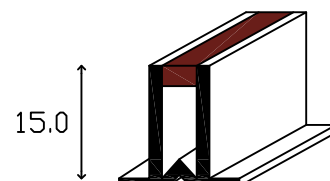

Scala 1:1



Esempio di posa Installation example



Posa con ceramica - Ceramic installation
Livello pavimentazione < 0,5 : 1 mm.
Level flooring < 0,5 : 1 mm.



Posa con marmo o granito
Laid with marble or granite
Livello pavimentazione = 0 mm.
Level flooring = 0 mm.

Profili e guscie igieniche in resina sintetica e alluminio di raccordo tra pavimenti e rivestimenti, per vasche e piatti doccia: resistenti ai principali agenti chimici.

Profiles and hygienic edge covers in synthetic resin for joins between flooring and cladding, for bath tubs and shower trays: resistant to the main chemical agents

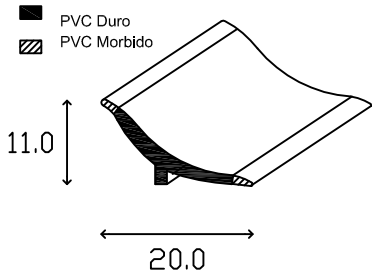

UNYcer®-G Profili guscia per rivestimenti - Edge covers for cladding

Guscia 11x20

ART.	MATERIALE MATERIAL	FINITURA FINISH	COLORE COLOUR	Misura Measure mm	Lung. Length mm
SRS1120BI	Resina Sintetica Synthetic resin	Bianco Ral 9003 White Ral 9003		11x20	2700

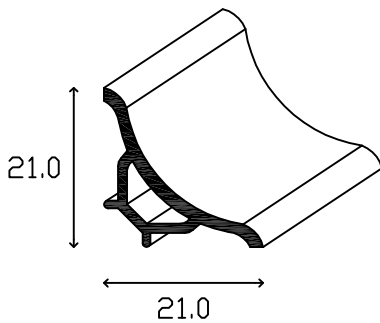

Guscia 21x21

ART.	MATERIALE MATERIAL	FINITURA FINISH	COLORE COLOUR	Misura Measure mm	Lung. Length mm
SRS2121BI	Resina Sintetica Synthetic resin	Bianco Ral 9003 White Ral 9003		21x21	2700
SRS2121GR	Resina Sintetica Synthetic resin	GRIGIO/Grey		21x21	2700



TAE2121BI



TAI2121BI



TC2121BI



G2121BI

Raccordi e Giunzioni per guscia 21x21 - Joints and connections for cover 21x21

ART.	DESCRIZIONE DESCRIPTION	MATERIALE MATERIAL	FINITURA FINISH	COLORE COLOUR	pz/conf. pcs/pack
TAE2121BI	Angolo esterno External corner	Resina Sintetica Synthetic resin	Bianco Ral 9003 White Ral 9003		2
TAI2121BI	Angolo interno Internal corner	Resina Sintetica Synthetic resin	Bianco Ral 9003 White Ral 9003		2
TC2121BI	Terminale Dx e Sx Left and Right Endings	Resina Sintetica Synthetic resin	Bianco Ral 9003 White Ral 9003		2
TG2121BI	Angolo esterno External corner	Resina Sintetica Synthetic resin	Bianco Ral 9003 White Ral 9003		2
TAE2121GR	Terminale Dx e Sx Left and Right Endings	Resina Sintetica Synthetic resin	Grigio Grey		2
TAI2121GR	Angolo esterno External corner	Resina Sintetica Synthetic resin	Grigio Grey		2
TC2121GR	Angolo interno Internal corner	Resina Sintetica Synthetic resin	Grigio Grey		2
TG2121GR	Terminale Dx e Sx Left and Right Endings	Resina Sintetica Synthetic resin	Grigio Grey		2

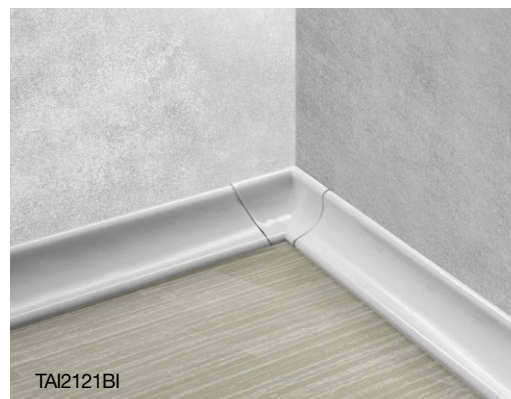

TAI2121BI



TAE2121BI

Unycer-G - Guscia di raccordo per pavimenti e rivestimenti in resina sintetica. La forma a guscia permette di ottenere una migliore pulizia e quindi igiene su tutti gli ambienti interni.

Unycer-G - Cove profile for synthetic resin floors and wall coverings. The shell-shaped design allows for improved cleaning and therefore better hygiene in all indoor environments.



SRS1111BI

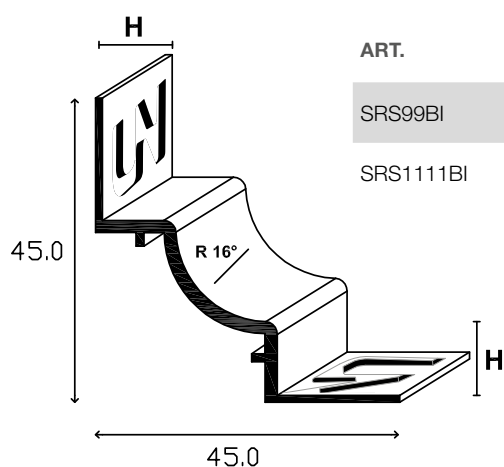

ART.	MATERIALE MATERIAL	FINITURA FINISH	COLORE COLOUR	Misura Measure mm	Lung. Leng. mm
SRS99BI	ResinaSintetica Synthetic resin	Bianco Ral 9003 White Ral 9003		9	2700
SRS1111BI	ResinaSintetica Synthetic resin	Bianco Ral 9003 White Ral 9003		11	2700

Raccordi e Giunzioni per guscia 9/11 - Joints and connections for cover 9/11

ART.	DESCRIZIONE DESCRIPTION	MATERIALE MATERIAL	FINITURA FINISH	COLORE COLOUR	pz/conf. pcs/pack
TAE9/11BI	Angolo esterno External corner	ResinaSintetica Synthetic resin	Bianco Ral 9003 White Ral 9003		2
TAI9/11BI	Angolo interno Internal corner	ResinaSintetica Synthetic resin	Bianco Ral 9003 White Ral 9003		2
TC9/11BI	Terminale Dx e Sx Left and Right Endings	ResinaSintetica Synthetic resin	Bianco Ral 9003 White Ral 9003		2
TAT9/11BI	Angolo esterno External corner	ResinaSintetica Synthetic resin	Bianco Ral 9003 White Ral 9003		2



TAE9/11BI



TCI9/11BI



TAI9/11BI



TAT9/11BI

Unycer-G - Guscia di raccordo in vero alluminio anodizzato e verniciato. La forma a guscia permette di ottenere una migliore pulizia e quindi igiene su tutti gli ambienti interni.

Unycer-G - Junction Shell in genuine anodized and painted aluminum. The shell shape allows for better cleaning and, consequently, improved hygiene in all indoor environments.



SA106A

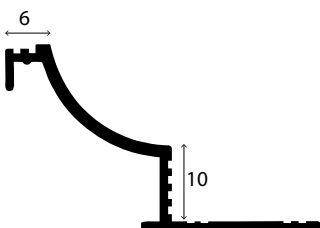

ARTICOLO	MATERIALE	MATERIAL	FINITURA	FINISH	Misura Misure mm	Lung. Leng. mm
SA106A	Alluminio	Alluminium	Argento	Silver	10	2700
SA106BI	Alluminio	Alluminium	Bianco Ral 9003	White Ral 9003	10	2700

Raccordi e terminali in vero alluminio / Fittings and terminals in real aluminum

ART.	DESCRIZIONE	DESCRIPTION	MATERIALE	MATERIAL	FINITURA	FINISH	pz/conf. pcs/pack
TAIVA106AL	Angolo esterno	External corner	Alluminio	Alluminium	Argento	Silver	1
TAEVA106AL	Angolo interno	Internal corner	Alluminio	Alluminium	Argento	Silver	1
TDSVA106AL	Terminale Dx e Sx	Left and Right Endings	Alluminio	Alluminium	Argento	Silver	1 dx + 1 sx
TAIVA106BI	Angolo esterno	External corner	Alluminio	Alluminium	Bianco ral 9003	White ral 9003	1
TAEVA106BI	Angolo interno	Internal corner	Alluminio	Alluminium	Bianco ral 9003	White ral 9003	1
TDSVA106BI	Terminale Dx e Sx	Left and Right Endings	Alluminio	Alluminium	Bianco ral 9003	White ral 9003	1 dx + 1 sx

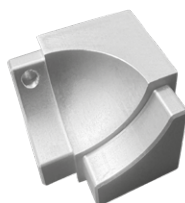

TAIVA106AL

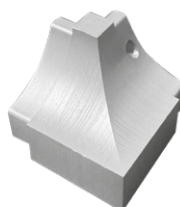

TAEVA106AL



TDSVA106AL

Unycer-G - Guscia di raccordo per pavimenti e rivestimenti in vero acciaio inox AISI 304 lucido.
La forma a guscia permette di ottenere una migliore pulizia e quindi igiene su tutti gli ambienti interni.
Unycer-G - Cove profile for floors and wall coverings, made of polished AISI 304 stainless steel.
The shell-shaped design allows for improved cleaning and thus better hygiene in all indoor environments



ART.	MATERIALE MATERIAL	FINITURA FINISH	Misura Misure mm	H. mm
SH106L/304	Acciaio Inox AISI 304 DIN 1.4301 Stainless steel AISI 304 DIN 1.4301	Lucido / Polished	2700	10



Angolo esterno e interno in vero acciaio inox aisi 304 tagliati e presaldati.
External and internal corner in genuine AISI 304 stainless steel, cut and pre-welded.

ART.	DESCRIZIONE DESCRIPTION	MATERIALE MATERIALE	FINITURA FINISH	H. mm
TAE106L/304	Angolo Esterno External corner	Acciaio Inox AISI 304 DIN 1.4301 Stainless steel AISI 304 DIN 1.4301	Lucido / Polished	10
TAI106L/304	Angolo Interno Internal corner	Acciaio Inox AISI 304 DIN 1.4301 Stainless steel AISI 304 DIN 1.4301	Lucido / Polished	10

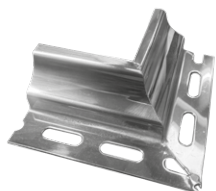

TAE106L/304

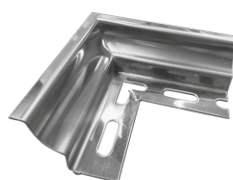

TAI106L/304



ART.	MATERIALE	MATERIAL	FINITURA	FINISH	Misura Misure mm	Lung. Leng. mm
SI3535L/304	Acciaio Inox AISI 304 DIN 1.4301	Stainless steel AISI 304 DIN 1.4301	Lucido con protettivo	Polished with protective	3000	35X35
SI3535S/304	Acciaio Inox AISI 304 DIN 1.4301	Stainless steel AISI 304 DIN 1.4301	Spazzolato con protettivo	Brushed with protective	3000	35X35

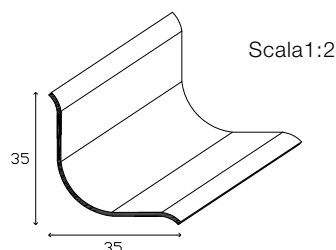

Esempio di posa
Installation example

Scala 1:2

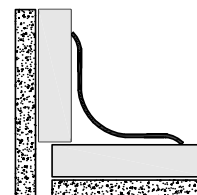

Raccordi in acciaio inox presaldato senza fessure
Fittings in pre-welded stainless steel without cracks

ART.	DESCRIZIONE DESCRIPTION	MATERIALE MATERIAL	FINITURA FINISH	pz/conf. pcs/pack
TAE3535L/304	Angolo Esterno External corner	Acciaio Inox AISI 304 DIN 1.4301 Stainless steel AISI 304 DIN 1.4301	Lucido con protettivo Polished with protective	1
TAE3535S/304	Angolo Esterno External corner	Acciaio Inox AISI 304 DIN 1.4301 Stainless steel AISI 304 DIN 1.4301	Spazzolato con protettivo Brushed with protective	1
TAI3535L/304	Angolo Interno Internal corner	Acciaio Inox AISI 304 DIN 1.4301 Stainless steel AISI 304 DIN 1.4301	Lucido con protettivo Polished with protective	1
TAI3535S/304	Angolo Interno Internal corner	Acciaio Inox AISI 304 DIN 1.4301 Stainless steel AISI 304 DIN 1.4301	Spazzolato con protettivo Brushed with protective	1

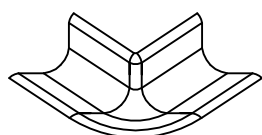

Scala 1:2



UNYcer-G

Profili e guscie igieniche di raccordo tra pavimenti e rivestimenti, per vasche e piatti doccia: resistenti ai principali agenti chimici.

Hygienic profiles and shells for the connection between floors and walls, for bathtubs and shower trays: resistant to the main chemical agents.

Lunghezza barre 2700mm / Bar length 2700mm

ART.	LEGA ALLOY	FINITURA FINISH	COLORE COLOUR	Misura Misure
SA2020A	Alluminio Aluminum	Argento Silver		20x20
SA2020BI	Alluminio Aluminum	Bianco White		20x20
SA202091	Alluminio Aluminum	Bianco Ral 9010 White Ral 9010		20x20
SA2020GA	Alluminio Aluminum	Grigio Antracite Grey Anthracite		20x20
SA2020GAS	Alluminio Aluminum	Grigio Antracite scuro Dark Anthracite grey		20x20

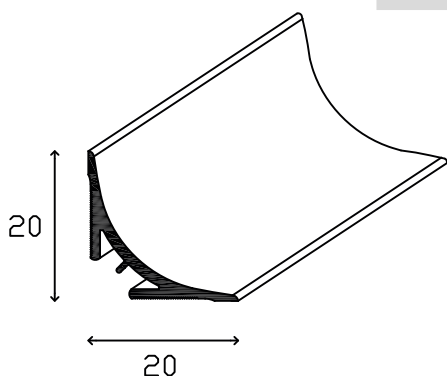

Esempio di posa
Installation example

Scala 1:1

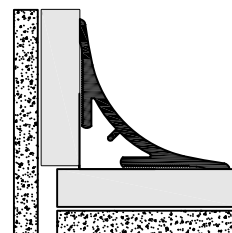

Lunghezza barre 2700mm / Bar length 2700mm

ART.	LEGA ALLOY	FINITURA FINISH	COLORE COLOUR	Misura Misure
SA4040A	Alluminio Aluminum	Argento Silver		40x40
SA4040BI	Alluminio Aluminum	Bianco White		40x40
SA404091	Alluminio Aluminum	Bianco Ral 9010 White Ral 9010		40x40
SA4040GA	Alluminio Aluminum	Grigio Antracite Grey Anthracite		40x40
SA4040GAS	Alluminio Aluminum	Grigio Antracite scuro Dark Anthracite grey		40x40

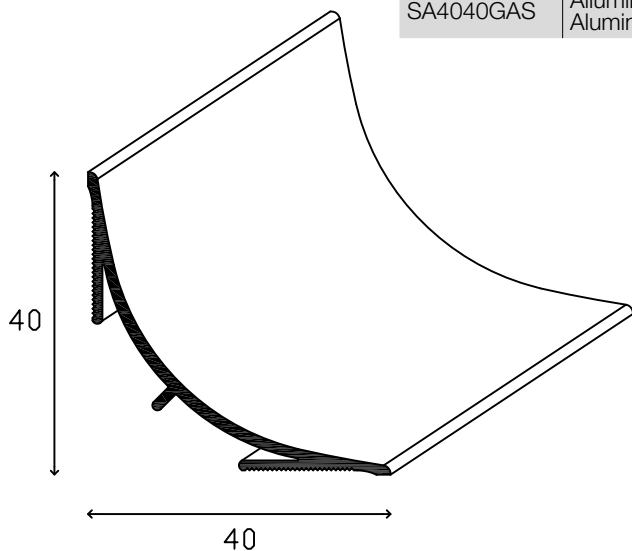

Esempio di posa
Installation example

Scala 1:1

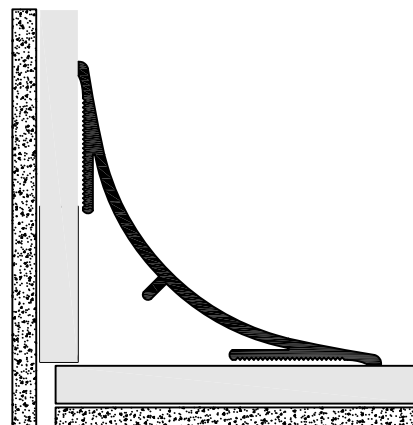

UNYcer-G Guscie PVC - Edge covers in PVC

Copriangolo interno 17x17 mm - Cover for internal corners 17x7 mm

ART.	LEGA ALLOY	FINITURA FINISH	Lungh. mm. Leng.mm	H.mm	ml per conf l.m./pack
CPVC1717BI	Resina Sintetica Synthetic resin	Bianco Ral 9003 White Ral 9003	3000	17x17	270



Raccordo igienico 20x20 mm bordi morbidi
Joint hygienic 20x20 mm with soft edges

ART.	LEGA ALLOY	FINITURA FINISH	Lungh. mm. Leng.mm	H.mm	ml per conf l.m./pack
SRS2020BI	Resina Sintetica Synthetic resin	Bianco Ral 9003 White Ral 9003	2500	20x20	125

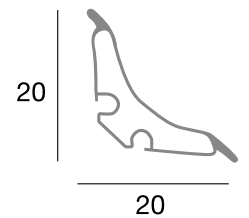

Raccordo igienico 45x45 mm - Joint hygienic 45x45 mm

ART.	LEGA ALLOY	FINITURA FINISH	Lungh. mm. Leng.mm	H.mm	ml per conf l.m./pack
SRS4545BI	Resina Sintetica Synthetic resin	Bianco Ral 9003 White Ral 9003	2000	45x45	20

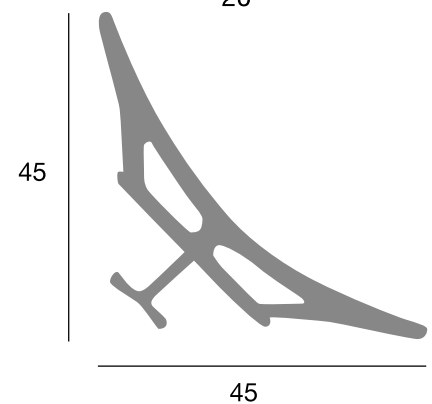

Scuscia 20x20 **Morbida** per rivestimenti
20x20 **Soft Shell** for Coatings

ART.	LEGA ALLOY	FINITURA FINISH	Lungh. mm. Leng.mm	H.mm	ml per conf l.m./pack
SPVCM2020BI	Pvc Morbido Soft PVC	Bianco White	2000	20X20	100

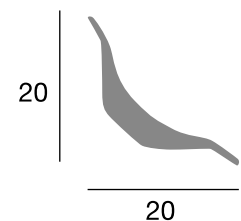

UNYcer-G Scuscia 30x30 **Morbida** per rivestimenti
30x30 **Soft Shell** for Coatings

ART.	MATERIALE MATERIAL	MATERIAL	FINITURA FINISH	FINISH	Misura Misure mm	Lung. Leng. mm
SPVCM3030BI	PVC Morbido	Soft PVC	Bianco	White	2000	30x30
SPVCM3030NE	PVC Morbido	Soft PVC	Nero	Black	2000	30x30

Esempio di posa
Installation example

Scala 1:2

